

POLILAN® Network Infrastructures



COMPANY HISTORY

Founded in 1994, Policabos - Soluções Técnicas de Condutores S.A., is committed to select, import, export, stock, integrate and distribute electrical and communication cables, connectors and accessories.

For over 20 years, Policabos has developed strategic partnerships with the main national and international manufacturers, built up on many years of expertise, hard work and cooperation.

Since 1995, the LAPP Group acquired a stake in the company, and since 2016, Policabos is 100% part of the group.

In June of 2018, part of the integration in the group, Policabos added to its name LAPP, hence becoming LAPP Policabos.

LAPP Policabos has over 60 employees, divided by the headquarters in Sintra, Lisboa, and the sales office in Gaia, Oporto.

The headquarters in Sintra has a warehouse with 4500 square meters which contains more than 4000 product references.

LAPP Policabos

Lapp Policabos is committed to be the supplier reference, for cable and communication solutions, connectors and accessories, in the national market, as well as the developer of the LAPP Group's business in Africa.

We want to be renowned for the flexibility and availability of our products, in the infrastructure sector, and also in the field of special data cables.

We aim to guarantee that our service fulfill our customers and other stakeholders, for which the quality of products and processes, stock management and technical support should be the basis of our company.

Involvement and commitment, training and transparency to all stakeholders and especially to our employees are the roots to the success of our mission.

COMPANY VALUES

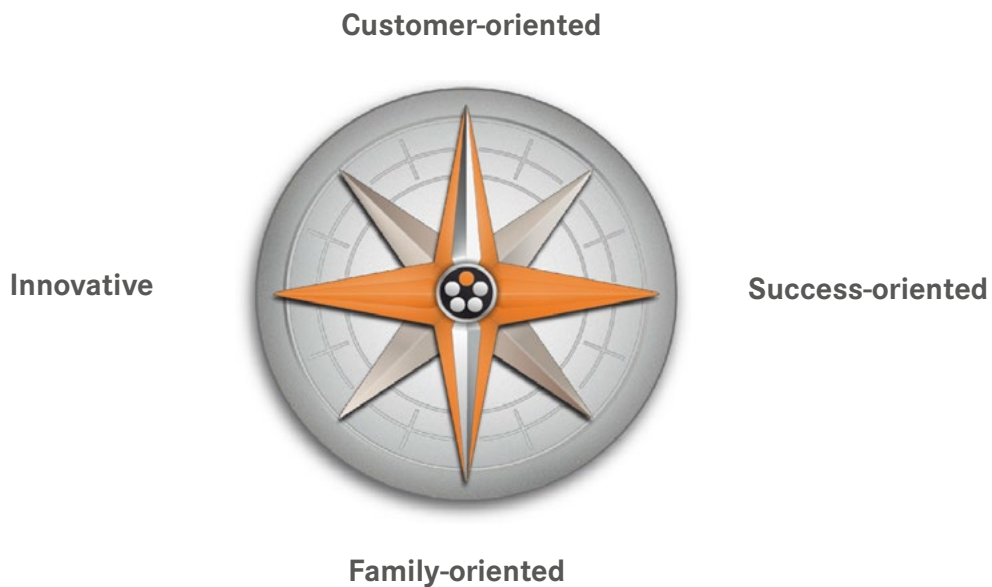

CUSTOMER-ORIENTED

We find quick and simple solutions for our customers – at a competitive price-performance ratio. We hold our customers and partners in the highest regard and guarantee them worldwide security of supply through international production sites. This enables them to be successful in their markets.

FAMILY-ORIENTED

We work together toward our goal in a spirit of trust. Respect and appreciation are just as important to us as personal responsibility and transparency. We actively train and develop our staff .

SUCCESS-ORIENTED

Our company is very versatile. It is our flexibility above all that secures profitable growth: our reaction to new challenges is quick and well-considered. Our processes are transparent, and we make sustainable, long-term-oriented decisions. We remain conscious of our risks while driving our growth. We also set standards for your benefit.

INNOVATIVE

We continuously develop our products, solutions and services. To ensure that there is no compromise when it comes to quality, we manufacture in our own plants. We pledge ourselves to ensure the well-being of our employees and the conservation of environmental resources.

LEGEND FOR ICONS

	Flame-retardant		Space requirement
	Fire-retardant		Low weight
	Fire resistance		Waterproof
	Interference signals		Robust
	Cold-resistant		100% dielectric
	Oil-resistant		Low Smoke Zero Halogen
	UV-resistant		Halogen Free
	Mechanical resistance		Power Over Ethernet
	Protection against rodents		Restriction of Hazardous Substances
	Extra protection against rodents		Construction Products Regulation
	Hydrocarbon-resistant		Marking that indicates conformity with health, safety, and environmental protection standards for products sold within the European Economic Area.
	Corrosion-resistant		
	Suitable for indoor use		
	Suitable for outdoor use		Harmonized power cable

CONTENT

POLILAN SOLUTION	3
Quick Selection Guide	
Data Communication Copper Solution	4
Fiber Optic Solution	5
Rack Solution	6
COPPER SOLUTION	7
Copper Solution	8
Cat 6A	9
Cat 6	15
Cat 5E	22
COPPER ACCESSORIES	25
Modules	26
Plugs	28
Patch panels	29
Faceplates	31
Patchcords	33
FIBER OPTIC	41
Introduction	42
Types of Fiber	43
Types of Cable	45
Indoor Cables	46
Universal Cables	49
Outdoor Cables	53
Special Cables	61
FIBER OPTIC ACCESSORIES	65
Patch Panel	66
Wall Boxes	67
Pigtail	74
Patch cord	75
Accessories	78
RACKS	79
Pedestal Racks	80
Wall Mount	84
Accessories	86
Shelf	88
TECHNICAL GUIDE	89



POLILAN® SOLUTION

Today, any building, commercial or residential, will only have full functionality if it has integrated a communications infrastructure solution. The same applies to a road, railway, or even an industry or photovoltaic park infrastructure - the telecommunications solution must exist to allow the transmission of telemetric data, video surveillance or even the local network.

POLILAN is a brand of structured cabling system that aims to respond to market needs regarding the quality and availability of solutions for data, voice and video networks. Complying with ISO / IEC 11801: 2011, EIA / TIA-568-D.2.1, EN 50173: 2013 standards.

Aimed at simplifying the customer's life, we have a brand that has a team specialized in technical support and logistical services.

POLILAN consists of:

- Copper solutions
- Copper accessories
- Fiber solutions
- Fiber accessories
- Telecommunications cabinets

Respect for the Environment

Aware that as a supplier we are introducing processed products into the market, it is our concern that POLILAN solutions do not use substances that are harmful to the environment, taking into account the following standards:

ROHS DIRECTIVE 2011/65 / EU

REACH REGULATION (EC) No 1907/2006 of the European Parliament & COMMISSION REGULATION (EU) No 143/2011

QUICK SELECTION GUIDE

Data Communication Copper Solution

Copper Infrastructure

CPR	CAT 6A				CAT 6				CAT 5E
	U/UTP	U/FTP	F/UTP	F/FTP	U/UTP	F/UTP	F/FTP	S/FTP	U/UTP

Cable

Pag. 7 - 23

SOLID

Box 305m LSZH	D _{ca}				2311002223	2311003029	2311003844		2311002217
Drum 500m PVC	E _{ca}				2311002857				2311002215
Drum 500m LSZH	D _{ca}	2311089912	2311003643	2311089956	2311089957	2311002223	2311003029		
Drum 500m Outdoor	F _{ca}				2311002858	2311090392	2311003841	2311001929	

FLEX

Drum 500m	NA				2311003644				
-----------	----	--	--	--	------------	--	--	--	--

Module

Pag. 26 - 28

Module Toolless (RJ45)	2311089913	2311002859	2311002859	2311002859	2311001807		2311002860		2311001807
Plugs (RJ45)	2311003855	2311003855	2311003855	2311003855	2311003855	2311003855	2311003855	2311003855	

Patch panels

Pag. 29 - 30

Patch Panel Full Loaded					2311002029				
Patch Panel Empty	2311002861	2311002861	2311002861	2311002861	2311002861	2311002861	2311002861	2311002861	2311002861

Faceplates and surface box

Pag. 31 - 32

Faceplate for 1 module (45x45)	2311003651	2311003651	2311003651	2311003651	2311003651	2311003651	2311003651	2311003651	2311003651
Faceplate for 2 modules (45x45)	2311003650	2311003650	2311003650	2311003650	2311003650	2311003650	2311003650	2311003650	2311003650
Faceplate for 1 module (86x86)	2311004461	2311004461	2311004461	2311004461	2311004461	2311004461	2311004461	2311004461	2311004461
Faceplate for 2 modules (86x86)	2311004460	2311004460	2311004460	2311004460	2311004460	2311004460	2311004460	2311004460	2311004460
Surface box 1 module	2311090630	2311090630	2311090630	2311090630	2311090630	2311090630	2311090630	2311090630	2311090630
Surface box 2 modules	2311003652	2311003652	2311003652	2311003652	2311003652	2311003652	2311003652	2311003652	2311003652

	CAT 6A				CAT 6				CAT 5E
	Shield	Shield	Shield	Shield	Unshield	Shield	Shield	Shield	Unshield

Patch cords

Pag. 33 - 39

Patch cord 0,5m Grey		2311003867	2311003867	2311003867	2311003646	2311001227	2311001227	2311001227	2311003646
Patch cord 1m Grey		2311001250	2311001250	2311001250	2311003647	2311001229	2311001229	2311001229	2311003647
Patch cord 3m Grey	2311003036	2311001241	2311001241	2311001241	2311003648	2311001232	2311001232	2311001232	2311003648
Patch cord 5m Grey		2311001256	2311001256	2311001256	2311003649	2311001233	2311001233	2311001233	2311003649
Patch cord 0,5m Red					2311001655	2311001228	2311001228	2311001228	2311001655
Patch cord 1m Red		2311001260	2311001260	2311001260	2311001620	2311001235	2311001235	2311001235	2311001620
Patch cord 3m Red		2311001258	2311001258	2311001258	2311001634				2311001634
Patch cord 5m Red		2311001261	2311001261	2311001261	2311001641				2311001641
Patch cord 0,5m Black					2311001616	2311001227	2311001227	2311001227	2311001616
Patch cord 1m Black		2311001268	2311001268	2311001268	2311001618	2311001229	2311001229	2311001229	2311001618
Patch cord 3m Black		2311001270	2311001270	2311001270	2311001632	2311001232	2311001232	2311001232	2311001632
Patch cord 5m Black		2311090480	2311090480	2311090480	2311001639	2311001233	2311001233	2311001233	2311001639
Patch cord 0,5m Yellow		2311003550	2311003550	2311003550	2311001659			2311001659	
Patch cord 1m Yellow		2311001264	2311001264	2311001264	2311001622			2311001622	
Patch cord 3m Yellow		2311001259	2311001259	2311001259	2311001636				
Patch cord 5m Yellow		2311001266	2311001266	2311001266	2311001234				

QUICK SELECTION GUIDE

Fiber Optic Solution

N° Fibers	OM3	OM4	SM(G652D)	G657A1
Cable Indoor - inside buildings, LSZH				Pag. 46 - 48
1				2311001132
2				2311003042
Universal Cable - With UV protection, can be used indoor or outdoor				Pag. 49 - 52
With antirodent protection - Non metallic armour				
4	2311004332	2311004341	2311001124	
6	2311004333	2311004342	2311004352	
8	2311001126	2311004343	2311004353	
12	2311001127	2311004344	2311001125	
16	2311004334	2311004345	2311004354	
24	2311004335	2311004346	2311004355	
36	2311004336	2311004347	2311004356	
48	2311004337	2311004348	2311004357	
72	2311004338	2311004349	2311004358	
96	2311004339	2311004350	2311004359	
144	2311004340	2311004351	2311004360	
With antirodent protection - Metallic armour				
4				
8				
18				
24			2311001131	
Without armour				
2				2311001128
4				
8				
12				
Outdoor Cable - With UV and antirodent protection				Pag. 53 - 60
Non metallic armour				
4	2311004406	2311004417	2311004428	
6	2311004407	2311004418	2311004429	
8	2311004408	2311004419	2311004430	
12	2311004409	2311004420	2311004431	
16	2311004410	2311004421	2311004432	
24	2311004411	2311004422	2311004433	
36	2311004412	2311004423	2311004434	
48	2311004413	2311004424	2311004435	
72	2311004414	2311004425	2311004436	
96	2311004415	2311004426	2311004437	
144	2311004416	2311004427	2311004438	
Metallic armour				
4			2311001174	
6				
8				
12			2311003009	
16			2311001175	
24			2311001175	
36			2311090436	
72			2311090109	2311090442
144			2311089976	
Special Cables				Pag. 61 - 63
SWA armour				
12			2311001178	
24			2311001179	
48			2311001180	
Oil resistant				
6			2311001184	
24			2311001185	
Hybrid - Energy + fiber				
2			2311004766	
4			2311004786	

QUICK SELECTION GUIDE

Rack Solution

Pedestal (floor)

Pag. 80 - 83

Height	Width	Depth	Front door glass		Front door perforated
			Flatpack (FP)	Assembled (NS)	Assembled (NS)
24U	60	60		2311001075	2311003929
	60	80		2311001076	2311090414
	80	80		2311003338	
	80	100			2311002881
33U	60	60		2311001077	
	60	80		2311001078	
	80	80		2311001079	
	80	100		2311001083	
42U	60	60		2311004125	2311001081
	60	80		2311002950	2311003742
	80	80	2311003653	2311001080	2311001087
	80	100			2311004603
47U	80	80			2311001097
	80	100			

Wall Rack

Pag. 84 - 85

Height	Width	Depth	Front door glass	
			Flatpack	Assembled
6U	60	40		2311001107
	60	45	2311003655	2311002865
9U	60	40		2311001105
	60	50	2311001108	2311001104
12U	60	60	2311003657	
	60	40		2311003842
	60	50		2311001103
	60	60		2311089894
15U	60	50		2311001106
	60	60		2311001111
20U	60	40		
	60	60		2311002891

Rack Accessories

Pag. 86 - 88

	Front door glass	
	Flatpack	Assembled
Thermostat with display	2311003659	
Thermostat with display	2311000953	
Ventilator with 1 Fan for wall racks	2311003661	2311000968
Ventilador 2 Fan for pedestal racks	2311003660	2311000976

Shelf	Depth (mm)	
2 fix points	250	2311000985
2 fix points	350	2311000945
2 fix points	400	2311090435
2 fix points	450	2311000980
2 fix points	600	2311003063
4 fix points	425 - 760	2311000988
4 fix points	1000	2311003089
4 fix points	600	2311000981

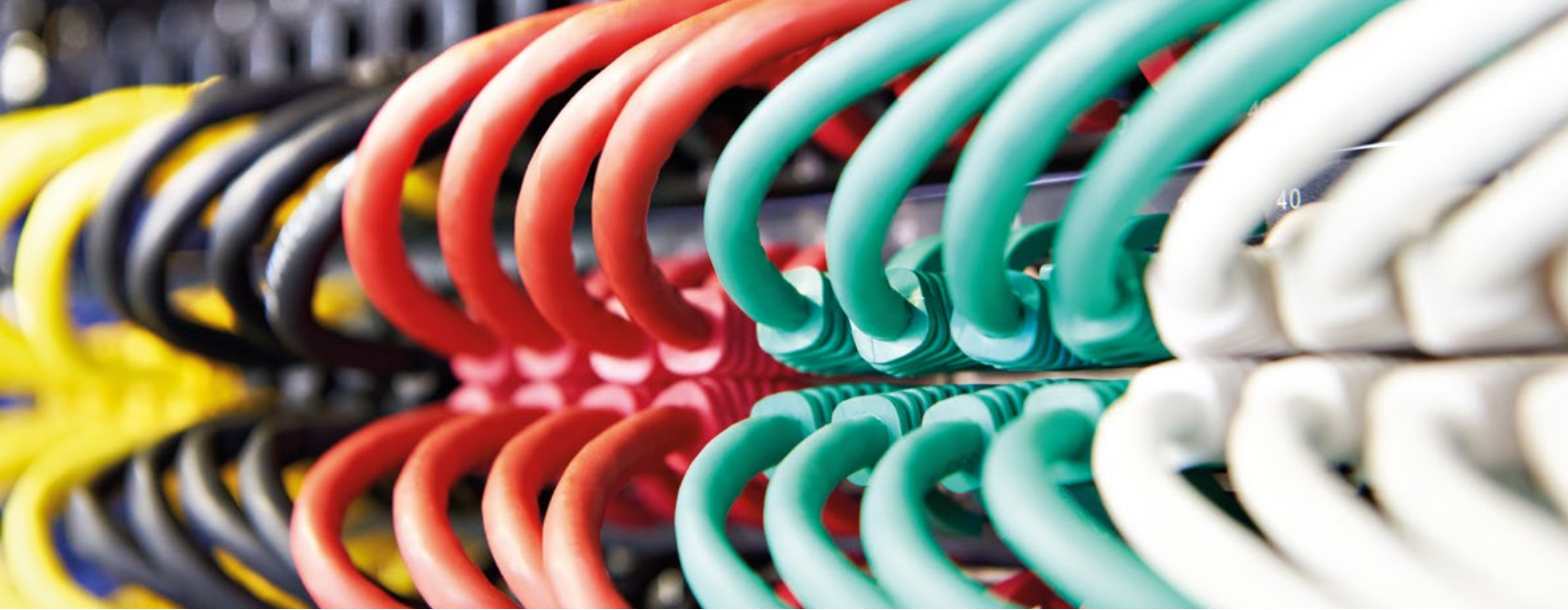

COPPER SOLUTION

COPPER SOLUTION	8
CAT 6A U/UTP (LSZH)	9
CAT 6A U/FTP (LSZH)	11
CAT 6A F/UTP (LSZH)	13
CAT 6 U/UTP (PVC or LSZH)	15
CAT 6 F/UTP (LSZH)	17
PATCH DATA CABLE CAT 6 U/UTP LSZH	19
CAT 6 U/UTP OUTDOOR (PE)	20
CAT 6 F/UTP OUTDOOR (PE)	21
CAT 6 S/FTP OUTDOOR (PE)	22
CAT 5E U/UTP (PVC or LSZH)	23

COPPER SOLUTION

Infrastructure categories or classes

In order to evaluate the performance of a communications infrastructure and ensure that cable networks are designed, installed and tested according to industry best practices, the following standards have been created: ISO/IEC11801 (the international standard), EN50173 (European standard) and ANSI/TIA568 (American).

These standards define the categories and/or classes of cables as well as the components that constitute a communications network. What distinguishes each of the categories (or Cat.) is the maximum frequency supported as well as the attenuation and interferences supported in the conductors. The higher the frequency supported of a cable, the lower its attenuation and the higher its immunity to interferences - the higher is its performance (or bandwidth supported) and the higher is its Category.

It should be noted that all cables have eight conductors - twisted in pairs and, the conductor's thickness, the torsion step, the spacing between pairs will influence on the category given to each cable.

Category	Class	Freq (Mhz)	Bandwith	Distance (meters)	Cable shield
5E	D	100	100 Mbps	100	With or without shield
6	E	250	1Gbps	100	With or without shield
6A	EA	500	>1Gbps	100	With or without shield
7	F	600	10 Gbps	100	With shield
7A	FA	1000	>10Gbps (multimedia)	100	With shield
8.2	II	2000	40 Gbps	30	With shield

Shield or unshield Cables

For speeds higher than 1Gbps the screened cables should be used specially where exist electromagnetic interference.

Until cat 6 in most of the application it is usual to use the unshield cables, when using shielding is more common on the group of the four pairs of the cable, but it can also have a shield on each pair for better EMC protection.

For the Cables higher than cat6A it's better to use shield cables specially on each pair, the reason is because the usage of higher frequencies will create a phenomenon of EMI between adjacent pairs on the same cable or between pairs from a cable to other pairs in different cable (called AlienCrossTalk)

CAT 6A U/UTP (LSZH) Copper Data Cable



Application

Solution category 6A unshield LSZH cables are designed for the following applications:

- 10BASE-T (IEEE 802.3)
- 4/16 Mbps TOKEN RING (IEEE 802.5)
- 100BASE-VG-AnyLAN
- 100 Mbps TP-PMD (ANSI X3T9.5)
- 100BASE-T (IEEE 802.3)
- 55/155 Mbps ATM
- 1000BASE-T (Gigabit Ethernet)
- 1.2 / 2.4 Gbps ATM
- 10G BASE-T

Standards

- IEC 61156-5
- EN 50288-10-1
- EN 50173
- ISO/IEC 11801
- EN 50575
- EN 50399
- EN 13501-6

CPR

- DoP Number: PoliDoP035_00
- Class: D_{ca}-S₂d₂a₁

Design

1. Conductor: Solid bare annealed copper 23 AWG
2. Insulation: Polyolefin
3. Stranding: Varying short pair lay-length (4 pairs)
4. Cross filler
5. NEXT Encapsulated Barrier
6. Sheath: LSZH Violet (RAL 4005)

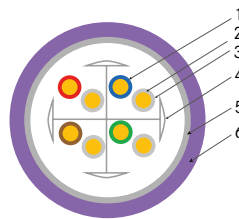

Electrical properties at 20°C

Nominal velocity of propagation (NVP)	% of light speed	70
Max. delay skew	ns/100m	≤ 40
Max. conductor DC resistance	(Ω/100m at 20°C)	≤ 9,5
Max. insulation resistance	MΩ/km	5000
Impedance	Ω ; value at 1-250 MHz	100

Technical Data

	Operating temperature range (°C) -20 up to 70
	Minimum bending radius Fixed installation: 6 x cable diameter
	Max. recommended pulling tension 80 N
	Flame test EN 50575 EN 50399

Article number	Description	Color	Outer sheath	Ø (mm)	Package	Weight (Kg/Km)
2311089912	CC U/UTP CAT6A 4P LSZH VT POLILAN	Violet	LSZH	7,3±0,3	Drum 500m	49,5

CAT 6A U/UTP (LSZH)

Copper Data Cable

Transmission Specifications

Freq.	ATTN	NEXT	PS-NEXT	ELFEXT (ACR-F)	PS-ELFEXT (PSACR-F)	ACR	PS-ACR	RL
MHz	dB/100m (max.)	dB (min.)	dB/100m (min.)	dB/100m (min.)	dB/100m (min.)	dB/100m (min.)	dB/100m (min.)	dB/100m (min.)
1	2.1	75.3	72.3	68.0	65.0	73.2	70.2	20.0
4	3.8	66.3	63.3	56.0	53.0	62.5	59.5	23.0
8	5.3	61.8	58.8	69.9	46.9	56.4	53.4	24.5
10	5.9	60.3	57.3	48.0	45.0	54.4	51.4	25.0
16	7.5	57.2	54.2	43.9	40.9	49.8	46.8	25.0
25	9.4	54.3	51.3	40.0	37.0	45.0	42.0	24.3
31.25	10.5	52.9	49.9	38.1	35.1	42.4	39.4	23.6
62.5	15.0	48.4	45.4	32.1	29.1	33.4	30.4	21.5
100	19.0	45.3	42.3	28.0	25.0	26.2	23.2	20.1
155	24.1	42.4	39.4	24.2	21.2	18.4	15.4	18.8
200	27.6	40.8	37.8	22.0	19.0	13.2	10.2	18.0
250	31.1	39.3	36.3	20.0	17.0	8.3	5.3	17.3
300	34.3	38.1	35.1	18.5	15.5	3.9	0.9	17.3
350	37.2	37.1	34.1	17.1	14.1	–	–	17.3
400	40.1	36.3	33.3	16.0	13.0	–	–	17.3
500	45.3	34.8	31.8	14.0	11.0	–	–	17.3

CAT 6A U/FTP (LSZH) Copper Data Cable



Application

Solution Category 6A U/FTP LSZH cables are designed to deliver a robust standards based performance ensuring optimum bandwidth for today's high speed network applications.

The cable is designed to support horizontal networking applications over distances up to 100 metres.

Support speeds up to 10G Base-T.

Standards

- ISO / IEC 11801,
- IEC 61156-5
- EN 50575
- EN 50399
- EN 13501-6
- EN 50288-10-1
- EN 50173
- EIA/TIA 568.2-1/568C.2

CPR

- DoP Number: PoliDoP022_00
- Class: D_{ca}-S₂d₂a₁

Design

1. Conductor: Solid bare copper AWG23
2. Insulation: colour-coded PE
3. Stranding: 4 pairs
4. Shield: Aluminum foil in each pair
5. Ripcord
6. Sheath: LSZH - Violet (RAL 4005)

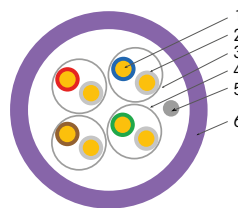

Electrical properties at 20°C

Nominal velocity of propagation (NVP)	% of light speed	70
Max. delay skew	ns/ 100m	≤ 40
Max. conductor DC resistance	(Ω/ 100m at 20°C	≤ 9,5
Max. insulation resistance	MΩ/km	5000
Impedance	Ω ; value at 1-250 MHz	100

Technical Data

	Operating temperature range (°C) -30 up to 70
	Minimum bending radius Fixed installation: 30mm
	Max. recommended pulling tension 80 N
	Flame test EN 50575 EN 50399

Article number	Description	Color	Outer sheath	Ø (mm)	Package	Weight (Kg/Km)
2311003643	CC U/FTP CAT6A 4P LSZH VT Polilan	Violet	LSZH	7,3±0,3	Bob. 500m	55,2

CAT 6A U/FTP (LSZH) Copper Data Cable

Transmission Specifications

Freq.	ATTN	NEXT	PS-NEXT	ELFEXT (ACR-F)	PS-ELFEXT (PSACR-F)	ACR	PS-ACR	RL
MHz	dB/100m (max.)	dB (min.)	dB/100m (min.)	dB/100m (min.)	dB/100m (min.)	dB/100m (min.)	dB/100m (min.)	dB/100m (min.)
1 *	2.1	75.3	72.3	68.0	65.0	73.2	70.2	20.0
4	3.8	66.3	63.3	56.0	53.0	62.5	59.5	23.0
8	5.3	61.8	58.8	69.9	46.9	56.4	53.4	24.5
10	5.9	60.3	57.3	48.0	45.0	54.4	51.4	25.0
16	7.5	57.2	54.2	43.9	40.9	49.8	46.8	25.0
25	9.4	54.3	51.3	40.0	37.0	45.0	42.0	24.3
31.25	10.5	52.9	49.9	38.1	35.1	42.4	39.4	23.6
62.5	15.0	48.4	45.4	32.1	29.1	33.4	30.4	21.5
100	19.0	45.3	42.3	28.0	25.0	26.2	23.2	20.1
155	24.1	42.4	39.4	24.2	21.2	18.4	15.4	18.8
200	27.6	40.8	37.8	22.0	19.0	13.2	10.2	18.0
250	31.1	39.3	36.3	20.0	17.0	8.3	5.3	17.3
300	34.3	38.1	35.1	18.5	15.5	3.9	0.9	17.3
350	37.2	37.1	34.1	17.1	14.1	–	–	17.3
400	40.1	36.3	33.3	16.0	–	–	–	17.3
500	45.3	34.8	31.8	14.0	–	–	–	17.3

* For information only

CAT 6A F/UTP (LSZH) Copper Data Cable



Application

Solution category 6A unshield LSZH cables are designed for the following applications:

- 10BASE-T (IEEE 802.3)
- 4/16 Mbps TOKEN RING (IEEE 802.5)
- 100BASE-VG-AnyLAN
- 100 Mbps TP-PMD (ANSI X3T9.5)
- 100BASE-T (IEEE 802.3)
- 55/155 Mbps ATM
- 100BASE-T (Gigabit Ethernet)
- 1.2 / 2.4 Gbps ATM
- 10G BASE-T

Standards

- IEC 61156-5
- EN 50288-10-1
- EN 50173
- ISO/IEC 11801
- EN 50575
- EN 50399
- EN 13501-6
- ANSI/TIA-568-C.2

CPR

- DoP Number: PoliDoP036_00
- Class: D_{ca}-S₂,d₂,a₁

Design

1. Conductor: Solid bare annealed copper 23 AWG
2. Insulation: Polyolefin
3. Stranding: Varying short pair lay-length (4 pairs)
4. Cross filler
5. Aluminium/Polyester foil.
6. Tinned copper drain wire
7. Sheath: LSZH Violet (RAL 4005)

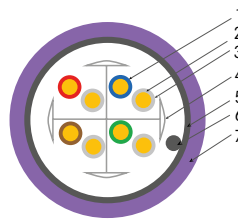

Electrical properties at 20°C

Nominal velocity of propagation (NVP)	% of light speed	70
Max. delay skew	ns/100m	≤ 40
Max. conductor DC resistance	(Ω/100m at 20°C)	≤ 9,5
Max. insulation resistance	MΩ/km	5000
Impedance	Ω ; value at 1-250 MHz	100

Technical Data

	Operating temperature range (°C) -20 up to 70
	Minimum bending radius Fixed installation: 6 x cable diameter
	Max. recommended pulling tension 80 N
	Flame test EN 50575 EN 50399

Article number	Description	Color	Outer sheath	Ø (mm)	Package	Weight (Kg/Km)
2311089956	CC F/UTP CAT6A 4P LSZH VT POLILAN	Violet	LSZH	7,6±0,3	Drum 500m	55,2

CAT 6A F/UTP (LSZH)

Copper Data Cable

Transmission Specifications

Freq.	ATTN	NEXT	PS-NEXT	ELFEXT (ACR-F)	PS-ELFEXT (PSACR-F)	ACR	PS-ACR	RL
MHz	dB/100m (max.)	dB (min.)	dB/100m (min.)	dB/100m (min.)	dB/100m (min.)	dB/100m (min.)	dB/100m (min.)	dB/100m (min.)
1	2.1	75.3	72.3	68.0	65.0	73.2	70.2	20.0
4	3.8	66.3	63.3	56.0	53.0	62.5	59.5	23.0
8	5.3	61.8	58.8	69.9	46.9	56.4	53.4	24.5
10	5.9	60.3	57.3	48.0	45.0	54.4	51.4	25.0
16	7.5	57.2	54.2	43.9	40.9	49.8	46.8	25.0
25	9.4	54.3	51.3	40.0	37.0	45.0	42.0	24.3
31.25	10.5	52.9	49.9	38.1	35.1	42.4	39.4	23.6
62.5	15.0	48.4	45.4	32.1	29.1	33.4	30.4	21.5
100	19.0	45.3	42.3	28.0	25.0	26.2	23.2	20.1
155	24.1	42.4	39.4	24.2	21.2	18.4	15.4	18.8
200	27.6	40.8	37.8	22.0	19.0	13.2	10.2	18.0
250	31.1	39.3	36.3	20.0	17.0	8.3	5.3	17.3
300	34.3	38.1	35.1	18.5	15.5	3.9	0.9	17.3
350	37.2	37.1	34.1	17.1	14.1	–	–	17.3
400	40.1	36.3	33.3	16.0	13.0	–	–	17.3
500	45.3	34.8	31.8	14.0	11.0	–	–	17.3

CAT 6 U/UTP (PVC or LSZH) Copper Data Cable



Application

Category 6 U / UTP cables are designed to create an Ethernet network solution that complies with Category 6, connection class E at 250MHz, in accordance with EN 50173-1 and ISO/IEC 11801.

For use in indoor environments, such as offices or ITED networks.

With excellent performance and capacity, it allows data, voice and PoE (Power over Ethernet) applications to power phones, cameras or wifi access points.

Standards

- EIA/TIA 568B.2-1/568C.2
- ISO / IEC 11801
- IEC 61156-5

CPR

Cat6 U/UTP LSZH:

- DoP Number: PoliDoP020_00
- Class: D_{ca}-S₂,d₂,a₁

Cat6 U/UTP PVC:

- DoP Number: PoliDoP021_00
- Class: E_{ca}

Design

- Conductor: solid bare copper 24 AWG
- Insulation: colour-coded PE
- Stranding: 4 pairs
- Ripcord (optional)
- Outer sheath: LSZH - White (RAL 9003) or PVC - Grey (RAL 7004)
- Rated temperature: 75°C



Electrical properties at 20°C

Nominal velocity of propagation (NVP)	% of light speed	69
Max. delay skew	ns/ 100m	≤ 45
Max. conductor DC resistance	(Ω/ 100m at 20°C	≤ 8,6
Max. insulation resistance	MΩ/km	5000
Impedance	Ω ; value at 1-250 MHz	100

Technical Data



Operating temperature range (°C)
-20 up to 70



Minimum bending radius (Installation)
58 mm



Max. recommended pulling tension
100 N



Flame test
EN 50575
EN 50399

Article number	Description	Color	Outer sheath	Ø (mm)	Package	Weight (Kg/Km)
2311002223	CC U/UTP CAT6 4P LSZH WH POLILAN	White	LSZH	5,6±0,2	Box 305 or Reel 500m	36
2311002857	CC U/UTP CAT6 4P PVC GY POLILAN	Grey	PVC	5,6±0,2	Reel 500m	36

CAT 6 U/UTP (PVC or LSZH) Copper Data Cable

Transmission Specifications

Freq.	ATTN	NEXT	PS-NEXT	ELFEXT	PS-ELFEXT	ACR	PS-ACR	RL
MHz	dB/100m (max.)	dB (min.)	dB (min.)	dB/100m (min.)	dB/100m (min.)	dB/100m (min.)	dB/100m (min.)	dB/100m (min.)
1	2.1	75.3	72.3	68.0	65.0	73.2	70.2	20.0
4	3.8	66.3	63.3	58.0	55.0	62.5	59.5	23.0
8	5.2	61.8	58.8	51.9	48.9	56.5	53.5	24.5
10	5.9	60.3	57.3	50.0	47.0	54.4	51.4	25.0
16	7.4	57.2	54.2	45.9	42.9	49.9	46.9	25.0
25	9.2	54.3	51.3	42.0	39.0	45.0	42.0	24.3
31.25	10.3	52.9	49.9	40.1	37.1	42.6	39.6	23.6
62.5	14.5	48.4	45.4	34.1	31.1	33.8	30.8	21.5
100	18.4	45.3	42.3	30.0	27.0	26.9	23.9	20.1
155	22.9	42.4	39.4	26.2	23.2	19.5	16.5	18.8
200	26.1	40.8	37.8	24.0	21.0	14.7	11.7	18.0
250	29.2	39.3	36.3	22.0	19.0	10.1	7.1	17.3
300	32.0	38.1	35.1	20.5	17.5	6.1	3.1	17.3
350	34.7	37.1	34.1	19.1	16.1	2.5	1.0	17.3

CAT 6 F/UTP (LSZH) Copper Data Cable



Application

Solution Category 6 F/UTP LSZH cables are designed to deliver a robust standards based performance ensuring optimum bandwidth for today's high speed network applications. The cable is designed to support horizontal networking applications over distances up to 100 metres.

Standards

- EIA/TIA 568B.2-1/568C.2
- EN 50575
- EN50399
- EN 50173
- EN 13501-6
- ISO / IEC 11801,
- IEC 61156-5

CPR

- DoP Number: PoliDoP034_00
- Class: D_{ca}-S₂,d₂,a₁

Design

1. Conductor: Solid bare copper 23 AWG
2. Insulation: colour-coded PE
3. Stranding: 4 pairs
4. Cross filler
5. Shield: Aluminium foil over the 4 pairs
5. Tinned copper drain wire
6. Outer jacket: LSZH (White - RAL 9003)

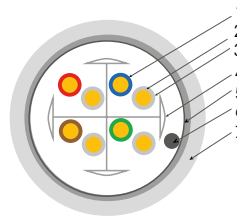

Electrical properties at 20°C

Nominal velocity of propagation (NVP)	% of light speed	72
Max. delay skew	ns/ 100m	≤ 40
Max. conductor DC resistance	(Ω/ 100m at 20°C	≤ 9,5
Max. insulation resistance	MΩ/km	5000
Impedance	Ω ; value at 1-250 MHz	100

Technical Data



Operating temperature range (°C)
-20 up to 70



Minimum bending radius
Fixed installation:
27,5 mm



Max. recommended pulling tension
80 N

Article number	Description	Color	Outer sheath	Ø (mm)	Package	Weight (Kg/Km)
2311003029	CC F/UTP CAT6 4P LSZH WH POLILAN	White	LSZH	7,2±0,3	Drum 500m or Box 305 mm	47,4

CAT 6 F/UTP (LSZH) Copper Data Cable

Transmission Specifications

Freq.	ATTN	NEXT	PS-NEXT	ELFEXT (ACR-F)	PS-ELFEXT (PSACR-F)	ACR	PS-ACR	RL
MHz	dB/100m (max.)	dB (min.)	dB/100m (min.)	dB/100m (min.)	dB/100m (min.)	dB/100m (min.)	dB/100m (min.)	dB/100m (min.)
1*	2.1	75.3	72.3	68.0	65.0	73.2	70.2	20.0
4	3.8	66.3	63.3	58.0	55.0	62.5	59.5	23.0
8	5.2	61.8	58.8	51.9	48.9	56.4	53.5	24.5
10	5.9	60.3	57.3	50.0	47.0	54.4	51.4	25.0
16	7.4	57.2	54.2	45.9	42.9	49.9	46.9	25.0
25	9.2	54.3	51.3	42.0	39.0	45.0	42.0	24.3
31.25	10.3	52.9	49.9	40.1	37.1	42.6	39.6	23.6
62.5	14.5	48.4	45.4	34.1	31.1	33.8	30.8	21.5
100	18.4	45.3	42.3	30.0	27.0	26.9	23.9	20.1
155	22.9	42.4	39.4	26.2	23.2	19.5	16.5	18.8
200	26.1	40.8	37.8	24.0	21.0	14.7	11.7	18.0
250	29.2	39.3	36.3	22.0	19.0	10.1	7.1	17.3
300*	32.0	38.1	35.1	20.5	17.5	6.1	3.1	17.3
350*	34.7	37.1	34.1	19.1	16.1	2.5	1.0	17.3

* For information only

Patch Data Cable CAT 6 U/UTP LSZH Copper Data Cable

Application

Stranded Category 6 U/UTP LSZH cables are designed to deliver a robust standards based performance ensuring optimum bandwidth for today's high speed network applications ideal to build patch cord.

Standards

- EIA/TIA 568B.2
- ISO / IEC 11801

Design

- Conductor: stranded bare copper 24 AWG
- Insulation: colour-coded PE
- Stranding: 4 pairs
- Outer sheath: LSZH (White RAL9003)
- Rated temperature: 75°C
- Conductor dimension: (7/0,18)+-0,02



Electrical Specifications

Nominal velocity of propagation (NVP)	% of light speed	69
Max. delay skew	ns/ 100m	≤ 45
Max. conductor DC resistance	(Ω/ 100m at 20°C	≤ 14
Max. insulation resistance	MΩ/km	5000
Impedance	Ω ; value at 1-250 MHz	100
Mutual capacitance	nF/ 100m; value at 1Khz	≤5,6
Max. capacitance unbalance	pF/ 100m (TIA/EIA-568B.2)	≤330

Technical Data



Operating temperature range (°C)
-20 up to 75



Minimum bending radius (Installation)
10 x outer diameter



Max. recommended pulling tension
110 N

Bulk cable weight (kg)
36 Kg/Km

Article number	Description	Color	Outer sheath	Ø (mm)	Package
2311003644	CC U/UTP CAT6 4P LSZH Flex GY Polilan	Grey	LSZH	5,8mm±0,3m	Drum 500m

POLILAN®

Copper Solution

CAT 6 U/UTP Outdoor (PE) Copper Data Cable



Application

Cat6 U/UTP cable for outdoor applications that demand category 6 connection class E at 250Mhz, in conformance with EN50173-1 and ISO/IEC11801.

With excellent performance and capacity, it allows data, voice and PoE (Power over Ethernet) applications to power phones, cameras or wifi access points.

Standards

- EN50173
- ISO/IEC11801
- IEC61156-5
- EN50288-6-1
- ANSI/TIA/EIA 568-C2
- EN 13501-6

CPR

- DoP Number: PoliDoP040_00
- Reaction to Fire: F_{ca}

Design

- Conductor: solid bare annealed copper 23 AWG
- Insulation: colour-coded Polyolefin (blue, green, orange, brown, white)
- Varying short pair lay-length (4 pairs).
- Ripcord (optional)
- Cross Filler
- Outer sheath: PE - Black (RAL 9005)
- Rated temperature: 70°C

Electrical Specifications

Nominal velocity of propagation (NVP)	% of light speed	65
Max. delay skew	ns/100m	≤ 40
Max. conductor DC resistance	(Ω/100m a 20°C)	≤ 9,38
Max. insulation resistance	MΩ/km	5000
Impedance	Ω ; value at 1-250 MHz	100

Technical Data



Operating temperature range (°C)
-20 to 70



Minimum bending radius (Installation)
23,5 mm



Max. recommended pulling tension
80 N



Flame test
CPR - F_{ca}



Article number	Description	Color	Outer sheath	Ø (mm)	Package	Weight (Kg/Km)
2311002858	CC U/UTP CAT6 4P PE-OUT BK Polilan	Black	PE	5,8±0,2	Drum 500m	34,5

CAT 6 F/UTP Outdoor (PE) Copper Data Cable



Application

Cat6 F/UTP cable for outdoor applications that demand category 6 connection class E at 250Mhz, in conformance with EN50173-1 and ISO/IEC 11801.

With excellent performance and capacity, it allows data, voice and PoE (Power over Ethernet) applications to power phones, cameras or wifi access points.

Standards

- EN50173
- ISO/IEC 11801
- IEC61156-5
- EN50288-6-1
- ANSI/TIA/EIA 568-C2
- EN 13501-6

CPR

- DoP Number: PoliDoP047_00
- Reaction to Fire: F_{ca}

Design

- Conductor: solid bare annealed copper 23 AWG
- Insulation: colour-coded Polyolefin (blue, green, orange, brown, white)
- Varying short pair lay-length (4 pairs).
- Ripcord (optional)
- Cross Filler
- Aluminium/polyester foil
- Outer sheath: PE - Black (RAL 9005)
- Rated temperature: 70°C

Electrical Specifications

Nominal velocity of propagation (NVP)	% of light speed	72
Max. delay skew	ns/ 100m	≤ 40
Max. conductor DC resistance	(Ω/ 100m a 20°C	≤ 9,5
Max. insulation resistance	MΩ/km	5000
Impedance	Ω ; value at 1-250 MHz	100

Technical Data

	Operating temperature range (°C) -20 to 70
	Minimum bending radius (Installation) 29 mm
	Max. recommended pulling tension 80 N
	Flame test CPR - F _{ca}



Article number	Description	Color	Outer sheath	Ø (mm)	Package	Weight (Kg/Km)
2311090392	CC F/UTP CAT6 4P PE-OUT BK Polilan	Black	PE	7,2±0,2	Drum 500m	43,5

CAT 6 S/FTP Outdoor (PE)

Copper Data Cable



Application

Data cable for outdoor installations. Suitable for all infrastructure network applications up to class E applications (250 MHz) in accordance with EN 50173-1 and ISO/IEC 11801.

Excellent shielding against EMI due to individually screened pairs and overall copper braid.

For POE applications allow the connectivity of phones, cameras and wifi devices.

Standards

- EIA/TIA 568B.2-1
- EIA/TIA/568C.2
- IEC 11801
- IEC 61156-5

CPR

- Class: F_{ca}

Design

- Cable category: Cat 6
- N° pairs: 4 pairs
- Shield: S/FTP
- AWG: 23
- Conductor: solid copper
- Outer sheath: PE (Black RAL9005)

Electrical Specifications

Nominal velocity of propagation (NVP)	% of light speed	69
Max. delay skew	ns/ 100m	≤ 45
Max. conductor DC resistance	(Ω/100m at 20°C	≤ 8,6
Max. insulation resistance	MΩ/km	5000
Impedance	Ω ; value at 1-250 MHz	100

Technical Data



Operating temperature range (°C)

-20 up to 75



Minimum bending radius

(fixed installation)
10 x outer diameter



Max. recommended pulling tension

80 N



Article number	Description	Nominal outer diameter (mm)	Package	Nominal cable weight (kg/km)
2311001929	CC S/FTP CAT6 4P PE-OUT BK POLILAN	7.7±0,3	Drum 500m	55

CAT 5E U/UTP (PVC or LSZH) Copper Data Cable



Application

Polilan Solution Category 5e U/UTP LSZH cable is designed to deliver a robust standards based performance ensuring optimum bandwidth for today's high speed network applications.

The cable is designed to support horizontal networking applications over distances up to 100 metres.

Each Category 5e U/UTP LSZH exceeds the minimum specified performance for Category 5e U/UTP cables and supports all CLASS D applications as defined within ISO/IEC 11801 (2nd Edition):2010.

Standards

- ISO/IEC 11801 2nd Edition
- ANSI/TIA 568-B-2
- EN 50173-1
- IEC 61156-5
- EN 50288-5-1
- 10Base-T (IEEE 802.3)
- 100Base-T (IEEE 802.3)
- 1000BASE-T (Gigabit Ethernet),
- ATM-155
- Token Ring 100Mbs-1

CPR

- DoP Number: PoliDoP037_00
- Reaction to Fire: E_{ca}

Design

- Conductor: single strand of 24 AWG solid copper
- Insulation: polyolefin
- Pairing: 4 pairs
- Shield: unshield
- Outer sheath: PVC (grey) or LSZH (white)

Electrical Specifications

Nominal velocity of propagation (NVP)	% of light speed	65
Delay skew	ns at 10Mhz	45
Max. conductor DC resistance	(Ω/ 100m at 20°C	<9,5
Insulation resistance (500V d.c)	MΩ/km	≥5000
Characteristic impedance	Ω at 1-100 MHz	100+-15 Ω
Capacitance	nF/ 100m	5,6

Technical Data



Operating temperature range (°C)
-45 up to 65



Minimum bending radius (Installation)
41,6 mm



Max. recommended pulling tension
(not for power purposes)
80 N



Flame test
EN 50575
EN 50399



Article number	Description	Colour	Outer sheath	Ø (mm)	Package	Weight (Kg/Km)
2311002217	CC U/UTP CAT5E 4P LSZH POLILAN	White	LSZH	5,2	Box 305 m	30
2311002215	CC U/UTP CAT5E 4P PVC POLILAN	Grey	PVC	5,2	Box 305 m	30

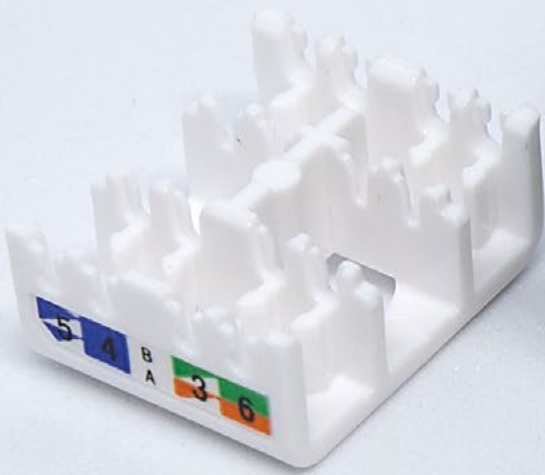

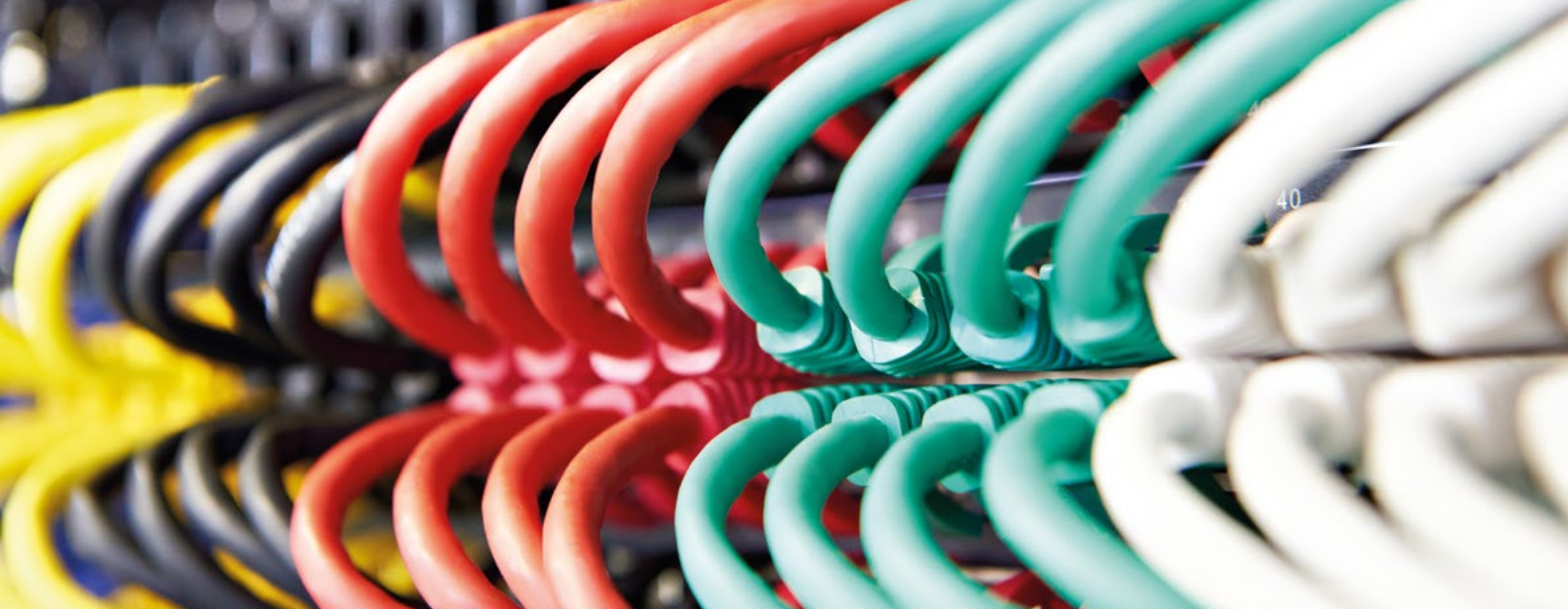

COPPER ACCESSORIES

MODULE CAT6A AND CAT6 RJ45 SHIELDED	26
MODULE CAT6A AND CAT6 RJ45 UNSHIELD	27
CAT6A RJ45 FIELD-PLUG	28
PATCH PANEL CAT6 U/UTP	29
PATCH PANEL 24X PORTS EMPTY	30
FACEPLATE KEYSTONE	31
DIN RAIL KEYSTONE ADAPTER	32
PATCH CORD CAT6 U/UTP LSZH	33
PATCH CORD CAT6 S/FTP LSZH	36
PATCH CORD CAT6A S/FTP LSZH	38

Module CAT 6A and CAT 6 RJ45 Shielded

ROHS

Description

This series keystone jacks work together with high speed cables, cords and panels to provide performance beyond proposed Category 6A/Category 6 standards. A new feature of this series jack is a universal colored wiring label that eliminates the need for separate codes for T568A/B wiring scheme.

- Available in Cat6A/Cat6, T568A/B wiring, meet or exceed TIA/EIA Cat6A/Cat6 requirements.
- Overall zinc alloy shielding design meets the industry standards.
- Compact jack design, 8 positions and 8 conductors.
- Contact: phosphor bronze, phosphor bronze with 6 to 50µ" gold plate.
- Accept 22-26 AWG solid with a insulation diameter of 0.4-0.6 mm.
- Easy to be terminated, low attenuation loss and high return loss.
- High reliability and superior performance.

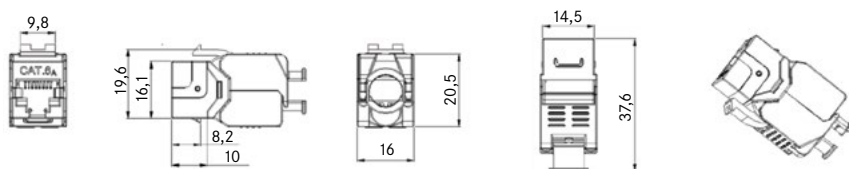
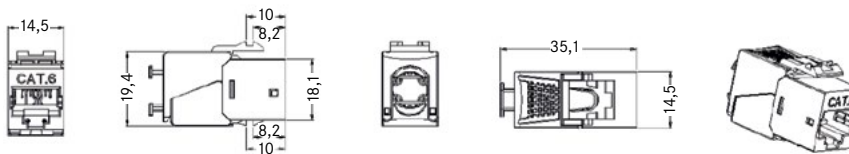
**Product Dimension (mm)****CAT 6A****CAT 6****Product Specifications**

Category:	6A / 6
Type Connector:	RJ45 8(8)
Screened:	Yes
AWG-range:	22-26
Special Tool:	Not necessary
Round cable:	Yes
Contact resistance (max.):	100 mΩ
Insulation resistance (min.):	500 MΩ
Return loss:	5.9 dB

Article number	Description
2311002859	Module RJ45 CAT6A STP
2311002860	Module RJ45 CAT6 STP

Approved Trade Product, but no POLILAN product.

Module CAT 6A and CAT 6 RJ45 Unshield



Application

This series keystone jacks work together with high speed cables, cords and panels to provide performance beyond proposed Category 6A / Category 6 standards. A new feature of this series jack is a universal colored wiring label that eliminates the need for separate codes for T568A/B wiring scheme.

- Compact jack design, 8 positions and 8 conductors.
- Contact: phosphor bronze, phosphor bronze with 6 to 50µ" gold plate.
- Accept 22-26 AWG solid with a insulation diameter of 0.4-0.6 mm.
- Easy to be terminated, low attenuation loss and high return loss.
- High reliability and superior performance.

Standards

- ISO/IEC 11801
- EN 50173-1
- Cat6A
- Cat6
- TIA/EIA 568-B



Product Dimension (mm)

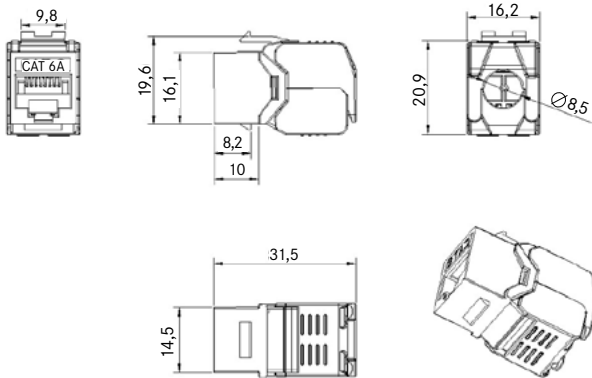

Product Specifications

Category:	6A/6
Type Connector:	RJ45 8(8)
Screened:	No
AWG-range:	22-26
Special Tool:	Not necessary
Round cable:	Yes
Contact resistance (max.):	100 mΩ
Insulation resistance (min.):	500 MΩ
Return loss:	4.8 dB

Article number	Description	Minimum order
2311089913	Module RJ45 CAT6A UTP	N x 24 units
2311001807	Module RJ45 CAT6 UTP	N x 24 units

Approved Trade Product, but no POLILAN product.



ROHS

Application

CAT6A performance plug easy tool-free assembly, comply with 10 Gigabit Ethernet application system, suitable for connection between FD to the outlet of the work area, providing up to 550MHz. Surveillance and industrial applications.

- Overall zinc alloy shielding design meets the industry standards.
- Meet the requirements of both T568A/T568B with clear color labels.
- Solid and corrosion phosphor bronze IDC enables over 250 terminations.
- Accept 23 AWG wires, phosphor bronze contact with 50µ" goldplate, with a durability of 1500 matching recycles.
- Easy installation with clear colored labels on termination cap.

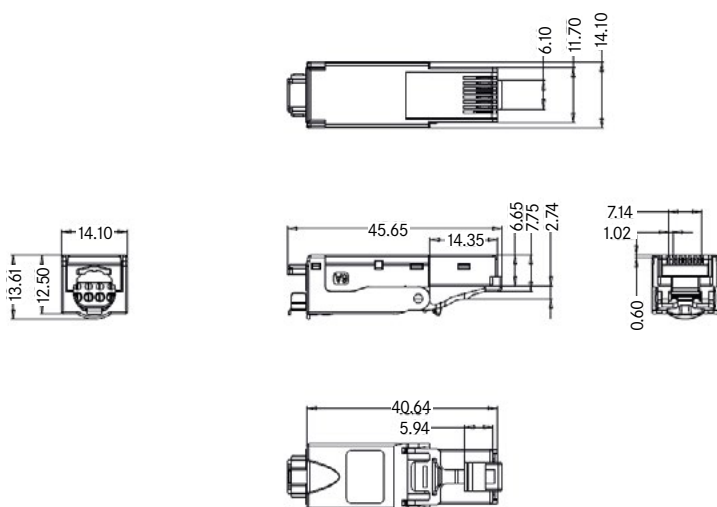
**Product Dimension (mm)****Product Specifications**

Category:	6A
Type Connector:	RJ45 8(8)
Screened:	Yes
AWG-range:	23-27
Special Tool:	Not necessary
Round cable:	Yes
Contact resistance (max.):	100 mΩ
Insulation resistance (min.):	500 MΩ
Return loss:	5.9 dB

Article number	Description
2311003855	Plug RJ45 CAT6A

Approved Trade Product, but no POLILAN product.

Patch Panel CAT 6 U/UTP



Application

Patch panel full loaded with 24 port RJ45 Cat6 U/UTP, 110 type, matches and exceeds CAT6 350MHZ connecting hardware specifications. Suitable for interaction and termination of horizontal cabling between devices, equipment and centralized points.

- CAT 6 UTP patch panel with unique exterior design, simple and compact.
- Compatible with 19-inch equipment racks, cabinets and wall mount shelf.
- PCB circuit board design reduces EMI/RFI interference, low attenuation loss and high return loss.
- High strength die-casted zinc alloy shielding design meets the industry shielding standards.
- Solid and corrosion phosphor bronze DC ensures over 250 terminations.
- Termination caps prevent wire from dropping off.
- With backward compatibility of CAT5E and lower classes.
- With 50µ" gold plate, durability is 1500 matching recycles.
- Solid and easy installation design saves installation and operation costs.
- All ports are clearly labeled, especially the large label in the front is helpful for network points id.



Product Dimension (mm)

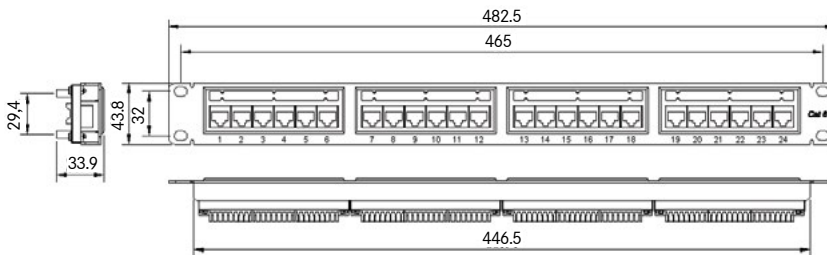

Product Specifications

Category:	6
Type Connector:	RJ45 8(8)
Screened:	No
Special Tool:	Yes (110)
Contact resistance (max.):	100 mΩ
Insulation resistance (min.):	500 MΩ
Return loss:	5.8 dB

ACCESSORIES (not included):

Tool Termination IDC (110) - PN 2311001890

Article number	Description
2311002029	Patch Panel RJ45 24x CAT6 UTP BK
2311001890	Tool Termination 110

Approved Trade Product, but no POLILAN product.

Patch Panel 24x Ports Empty

ROHS



Application

The 24-port empty patch panel matches with the installation of different kinds of modular jacks, complies with Gigabit Ethernet applications, and it is suitable for interaction and termination of horizontal cabling between devices, equipment and centralized points, as well as fits for 19" equipment racks and cabinets.



- Unique exterior design, simple and compact with beautiful appearance.
- High quality engineering plastic and steel sheet with high strength.
- Ergonomic design, convenient module snap-in installation.
- Consistency black surface with any other equipment.
- Be compatible with various performance modules: shielded or unshielded.
- Solid and easy installation design saves installation and operation costs.
- Be compatible with 19-inch equipment racks, cabinets, and wall mount shelf.
- All ports are large front-end marked, easier use for operation.
- The back ends with a cable manager that effectively guides the cable to the termination point.

Product Dimension (mm)

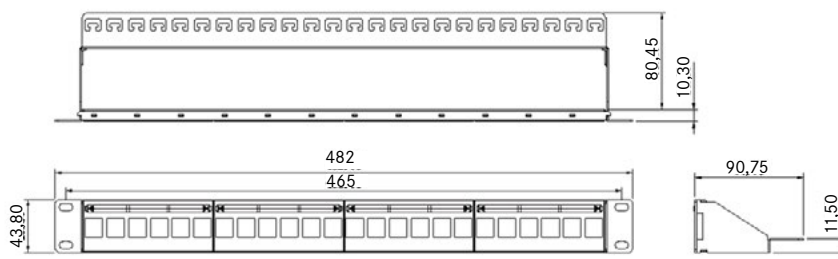
**Use with:****PN:****Module Cat6 UTP**

2311001807

Module Cat6A STP

2311002859

Article number**Description**

2311002861

PPANEL KEYSTONE 24PORT EMPTY BK

Approved Trade Product, but no POLILAN product.

Faceplate Keystone

Application

Suitable for different kinds of modular jack installation, widely used in working area network cabling.

- Size: 45x45 French Style.
- Embedded surface box, easy to install; Panel surface with embedded charts and label positions for easy definition of data and voice terminal.
- With anti-dust sliding port-cover.
- Available in the 1-port and 2-port faceplate.
- Made of high quality ABS&PC.

Product Dimension (mm)

One port version:

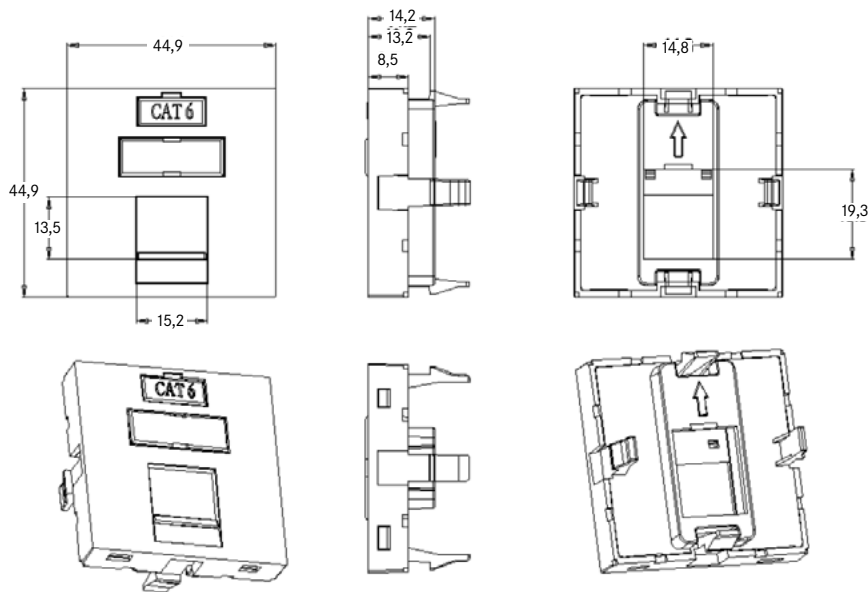

Article number	Description
2311003651	Faceplate Keystone 45x45mm 1 Module
2311003650	Faceplate Keystone 45x45mm 2 Modules
2311004460	Faceplate Keystone 86x86mm 2 Modules
2311004461	Faceplate Keystone 86x86mm 1 Module

Approved Trade Product, but no POLILAN product.

Din Rail Keystone Adapter

ROHS

Application

This accessory hold one RJ45 keystone shield or unshield on a din-rail.
 Can be fitted onto any 35 mm standard (DIN) rail - there must be a minimum distance of 10 mm between the rail and the back plane for fitting the rail adapter.
 Delivery without module.
 Plastic housing with labelling field and dust shutter.



Product Dimension (mm)

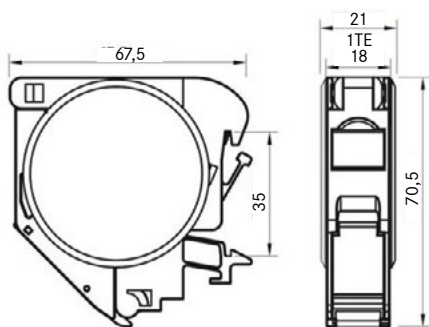

Article number	Description
2311002021	Accessory din Rail Keystone Adapter

Approved Trade Product, but no POLILAN product.

Patch Cord CAT 6 U/UTP LSZH



Application

Cat.6 U/UTP RJ45 patch cable ensures good performance for Gigabit Ethernet 1000Base-T and Fast Ethernet 100Base-T applications.

Standards

- ISO/IEC 11801EN50173-1
- IEC 60603-7-4
- IEC60332-1
- IEC60754-2
- IEC61034
- TIA/EIA 568B.2-1



Design

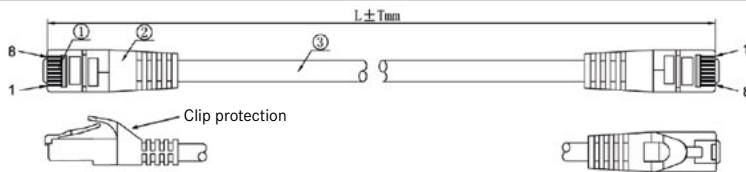

- 1) Connector RJ45 8P8C Gold plated
- 2) Molded Anti-kink sleeve same cable's color.
- 3) Cable Cat6 4x2xAWG24/7

Technical Data

Cable construction	4x2 conductors
AWG	24/7
Cable diameter	5,9 mm
Conductor material	CCA
Braid	Unshield
Type of connectors	RJ45, IEC-60603-7-4
Pin assignment	1:1
Anti-kink sleeve	Moulded
Locking lever	TRUE
Flame retardant version	TRUE IEC60332-1
Halogen free	TRUE IEC60754-2
Low Smoke	TRUE IEC61034
Oil resistant (acc. EN 60811-2-1)	FALSE
Silicone Free	TRUE
Operating temperature (°C)	0 - 60°C

Electrical and Transmission Data

Bandwith	250 Mhz
Transmission	5 Gbit
PoE class	PoE acc. to IEEE802.3af PoE+ acc. to IEEE802.3at 4PPoE acc. to IEEE802.3bt

Patch Cord CAT 6 U/UTP LSZH

Article number	Description	Lenght	Color
2311001614	PCORD RJ45 CAT6 U/UTP LSZH GY 0,25M	0,25	Grey
2311001615	PCORD RJ45 CAT6 U/UTP LSZH GY 0,5M	0,5	Grey
2311001617	PCORD RJ45 CAT6 U/UTP LSZH GY 1M	1	Grey
2311001665	PCORD RJ45 CAT6 U/UTP LSZH GY 1,5M	1,5	Grey
2311001624	PCORD RJ45 CAT6 U/UTP LSZH GY 2M	2	Grey
2311002942	PCORD RJ45 CAT6 U/UTP LSZH GY 2M	2	Grey
2311001631	PCORD RJ45 CAT6 U/UTP LSZH GY 3M	3	Grey
2311001638	PCORD RJ45 CAT6 U/UTP LSZH GY 5M	5	Grey
2311001666	PCORD RJ45 CAT6 U/UTP LSZH GY 7,5M	7,5	Grey
2311001645	PCORD RJ45 CAT6 U/UTP LSZH GY 10M	10	Grey
2311001648	PCORD RJ45 CAT6 U/UTP LSZH GY 15M	15	Grey
2311003776	PCORD RJ45 CAT6 U/UTP LSZH RD 0,25M	0,25	Red
2311001655	PCORD RJ45 CAT6 U/UTP LSZH RD 0,5M	0,5	Red
2311001620	PCORD RJ45 CAT6 U/UTP LSZH RD 1M	1	Red
2311001627	PCORD RJ45 CAT6 U/UTP LSZH RD 2M	2	Red
2311001634	PCORD RJ45 CAT6 U/UTP LSZH RD 3M	3	Red
2311001641	PCORD RJ45 CAT6 U/UTP LSZH RD 5M	5	Red
2311001646	PCORD RJ45 CAT6 U/UTP LSZH RD 10M	10	Red
2311003445	PCORD RJ45 CAT6 U/UTP LSZH RD 15M	15	Red
2311001662	PCORD RJ45 CAT6 U/UTP LSZH BU 0,25M	0,25	Blue
2311001660	PCORD RJ45 CAT6 U/UTP LSZH BU 0,5M	0,5	Blue
2311001619	PCORD RJ45 CAT6 U/UTP LSZH BU 1M	1	Blue
2311003441	PCORD RJ45 CAT6 U/UTP LSZH BU 1,5M	1,5	Blue
2311001626	PCORD RJ45 CAT6 U/UTP LSZH BU 2M	2	Blue
2311001633	PCORD RJ45 CAT6 U/UTP LSZH BU 3M	3	Blue
2311001640	PCORD RJ45 CAT6 U/UTP LSZH BU 5M	5	Blue
2311001657	PCORD RJ45 CAT6 U/UTP LSZH BU 10M	10	Blue
2311001649	PCORD RJ45 CAT6 U/UTP LSZH BU 15M	15	Blue
2311001668	PCORD RJ45 CAT6 U/UTP LSZH OR 1M	1	Orange
2311003512	PCORD RJ45 CAT6 U/UTP LSZH OR 3M	3	Orange
2311003513	PCORD RJ45 CAT6 U/UTP LSZH OR 5M	5	Orange
2311001667	PCORD RJ45 CAT6 U/UTP LSZH PL 2M	2	Purple
2311003777	PCORD RJ45 CAT6 U/UTP LSZH YE 0,25M	0,25	Yellow
2311001659	PCORD RJ45 CAT6 U/UTP LSZH YE 0,5M	0,5	Yellow
2311001622	PCORD RJ45 CAT6 U/UTP LSZH YE 1M	1	Yellow

Patch Cord CAT 6 U/UTP LSZH

Article number	Description	Lenght	Color
2311003744	PCORD RJ45 CAT6 U/UTP LSZH YE 1,5M	1,5	Yellow
2311001629	PCORD RJ45 CAT6 U/UTP LSZH YE 2M	2	Yellow
2311001636	PCORD RJ45 CAT6 U/UTP LSZH YE 3M	3	Yellow
2311001643	PCORD RJ45 CAT6 U/UTP LSZH YE 5M	5	Yellow
2311001661	PCORD RJ45 CAT6 U/UTP LSZH YE 10M	10	Yellow
2311001654	PCORD RJ45 CAT6 U/UTP LSZH GN 0,5M	0,5	Green
2311001623	PCORD RJ45 CAT6 U/UTP LSZH GN 1M	1	Green
2311001630	PCORD RJ45 CAT6 U/UTP LSZH GN 2M	2	Green
2311001637	PCORD RJ45 CAT6 U/UTP LSZH GN 3M	3	Green
2311001644	PCORD RJ45 CAT6 U/UTP LSZH GN 5M	5	Green
2311001647	PCORD RJ45 CAT6 U/UTP LSZH GN 10M	10	Green
2311001650	PCORD RJ45 CAT6 U/UTP LSZH GN 15M	15	Green
2311001616	PCORD RJ45 CAT6 U/UTP LSZH BK 0,5M	0,5	Black
2311001618	PCORD RJ45 CAT6 U/UTP LSZH BK 1M	1	Black
2311001625	PCORD RJ45 CAT6 U/UTP LSZH BK 2M	2	Black
2311001632	PCORD RJ45 CAT6 U/UTP LSZH BK 3M	3	Black
2311001639	PCORD RJ45 CAT6 U/UTP LSZH BK 5M	5	Black
2311001656	PCORD RJ45 CAT6 U/UTP LSZH BK 10M	10	Black
2311001670	PCORD RJ45 CAT6 U/UTP LSZH BK 15M	15	Black
2311001664	PCORD RJ45 CAT6 U/UTP LSZH MG 3M	3	Magenta
2311001669	PCORD RJ45 CAT6 U/UTP LSZH MG 3M	3	Magenta
2311003775	PCORD RJ45 CAT6 U/UTP LSZH WH 0,25M	0,25	White
2311001621	PCORD RJ45 CAT6 U/UTP LSZH WH 1M	1	White
2311001628	PCORD RJ45 CAT6 U/UTP LSZH WH 2M	2	White
2311001635	PCORD RJ45 CAT6 U/UTP LSZH WH 3M	3	White
2311001642	PCORD RJ45 CAT6 U/UTP LSZH WH 5M	5	White
2311001658	PCORD RJ45 CAT6 U/UTP LSZH WH 10M	10	White
2311001663	PCORD RJ45 CAT6 U/UTP LSZH WH 15M	15	White
2311001672	PCORD RJ45 CAT6 U/UTP LSZH VT 2M	2	Violet

Patch Cord CAT 6 S/FTP LSZH**Application**

Shielded Cat.6 RJ45 patch cable ensures excellent performance for Gigabit Ethernet 1000Base-T, Fast Ethernet 100Base-T and POE (802.3af) applications.

Standards

- ISO/IEC 11801 EN50173-1
- IEC-60603-7-5
- IEC60332-1
- IEC60754-2
- IEC61034
- TIA/EIA 568B.2-1

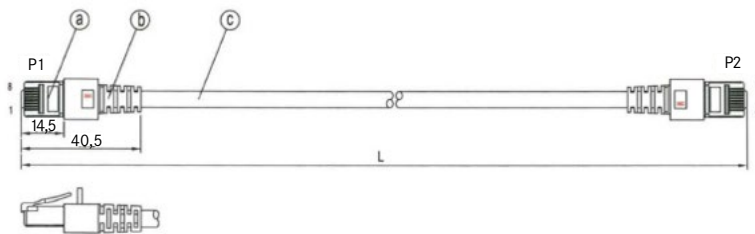
**Design**

- a) Conector RJ45 8P8C Gold plated
 b) Molded Anti-kink sleeve same cable's color.
 c) Cable Cat6 4x2xAWG27/7

Technical Data

Cable construction	4x2 conductors
AWG	27/7
Cable diameter	6,2 mm
Conductor material	Copper Wire
Braid	Tinned Copper Wire
Type of connectors	RJ45 shielded, IEC-60603-7-5
Pin assignment	1:1
Anti-kink sleeve	Moulded
Locking lever	TRUE
Flame retardant version	TRUE IEC60332-1
Halogen free	TRUE IEC60754-2
Low Smoke	TRUE IEC61034
Oil resistant (acc. EN 60811-2-1)	FALSE
Silicone Free	TRUE
Operating temperature (°C)	0 - 60°C

Electrical and Transmission Data

Conductor resistance DC	185 Ω/km
Loop resistance	370 Ω/km
Resistance unbalance	5 %
Insulation resistance	10 MΩ
Contact resistance	30 mΩ
PoE class	PoE acc. to IEEE802.3af PoE+ acc. to IEEE802.3at 4PPoE acc. to IEEE802.3bt

Patch Cord CAT 6 S/FTP LSZH

Article number	Description	Lenght	Color
2311001227	PCORD RJ45 CAT6 S/FTP LSZH GY 0,5M	0,5	Grey
2311001229	PCORD RJ45 CAT6 S/FTP LSZH GY 1M	1	Grey
2311001230	PCORD RJ45 CAT6 S/FTP LSZH GY 2M	2	Grey
2311001232	PCORD RJ45 CAT6 S/FTP LSZH GY 3M	3	Grey
2311001233	PCORD RJ45 CAT6 S/FTP LSZH GY 5M	5	Grey
2311001242	PCORD RJ45 CAT6 S/FTP LSZH GY 10M	10	Grey
2311001246	PCORD RJ45 CAT6 S/FTP LSZH GY 50M	50	Grey
2311001228	PCORD RJ45 CAT6 S/FTP LSZH RD 0,5M	0,5	Red
2311001235	PCORD RJ45 CAT6 S/FTP LSZH RD 1M	1	Red
2311001255	PCORD RJ45 CAT6 S/FTP LSZH RD 1,5M	1,5	Red
2311001231	PCORD RJ45 CAT6 S/FTP LSZH RD 2M	2	Red
2311001295	PCORD RJ45 CAT6 S/FTP LSZH BU 3M	3	Blue
2311001296	PCORD RJ45 CAT6 S/FTP LSZH BU 5M	5	Blue
2311001297	PCORD RJ45 CAT6 S/FTP LSZH BU 10M	10	Blue
2311001236	PCORD RJ45 CAT6 S/FTP LSZH GN 2M	2	Green
2311001239	PCORD RJ45 CAT6 S/FTP LSZH GN 5M	5	Green
2311001294	PCORD RJ45 CAT6 S/FTP LSZH GN 3M	3	Green
2311001237	PCORD RJ45 CAT6 S/FTP LSZH BK 2M	2	Black
2311001310	PCORD RJ45 CAT6 S/FTP LSZH BN 1M	1	Brown
2311001335	PCORD RJ45 CAT6 S/FTP LSZH BN 1,5M	1,5	Brown
2311001311	PCORD RJ45 CAT6 S/FTP LSZH BN 2M	2	Brown
2311001312	PCORD RJ45 CAT6 S/FTP LSZH BN 3M	3	Brown
2311001323	PCORD RJ45 CAT6 S/FTP LSZH VT 2M	2	Violet
2311001314	PCORD RJ45 CAT6 S/FTP LSZH WH 1M	1	White
2311001238	PCORD RJ45 CAT6 S/FTP LSZH YE 2M	2	Yellow
2311001234	PCORD RJ45 CAT6 S/FTP LSZH YE 5M	5	Yellow

Patch Cord CAT 6A S/FTP LSZH**Application**

The shielded Cat. 6A RJ45 patch cable ensures excellent performance for 10 Gigabit Ethernet applications. The TPE outer sheath makes the cable highly flexible and thus easier to handle.

The moulded grommet captivates with its slim design and thus simplifies the insertion process in cramped conditions. To be used in every applications where performance is a demand.

Standards

- ISO/IEC 11801 EN50173-1
- IEC-60603-7-5
- IEC60332-1
- IEC60754-2
- IEC61034
- TIA/EIA 568B.2-1

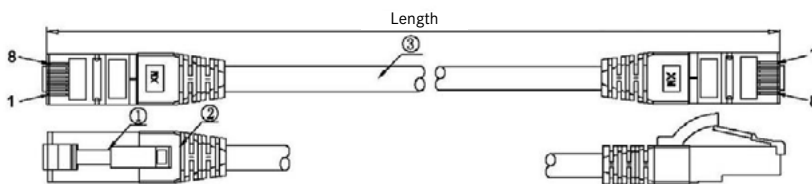
**Design****Technical Data**

Cable construction	Cat7, 4x2 conductors
AWG	26/7
Cable diameter	6,5 mm
Conductor material	Copper Wire
Braid	Tinned Copper Wire
Type of connectors	RJ45 shielded, IEC-60603-7-5
Pin assignment	1:1
Anti-kink sleeve	Moulded
Locking lever	TRUE
Flame retardant version	TRUE IEC60332-1
Halogen free	TRUE IEC60754-2
Low Smoke	TRUE IEC61034
Oil resistant (acc. EN 60811-2-1)	FALSE
Silicone Free	TRUE
Operating temperature (°C)	-20°C - 60°C

Electrical and Transmission Data

Conductor resistance DC	142 Ω/km
Loop resistance	284 Ω/km
Resistance unbalance	2 %
Insulation resistance	100 MΩ
Contact resistance	30 mΩ
Bandwith	500 Mhz
Transmission	10 Gbit
PoE class	PoE acc. to IEEE802.3af PoE+ acc. to IEEE802.3at 4PPoE acc. to IEEE802.3bt

Patch Cord CAT 6A S/FTP LSZH

Article number	Description	Lenght	Color
2311003867	PCORD RJ45 CAT6A S/FTP GY 0,5M	0,5	Grey
2311003550	PCORD RJ45 CAT6A S/FTP YE 0,5M	0,5	Yellow
2311001250	PCORD RJ45 CAT6 S/FTP LSZH GY 1M	1	Grey
2311001257	PCORD RJ45 CAT6A S/FTP LSZH GN 1M	1	Green
2311001260	PCORD RJ45 CAT6A S/FTP LSZH RD 1M	1	Red
2311001264	PCORD RJ45 CAT6A S/FTP LSZH YE 1M	1	Yellow
2311001268	PCORD RJ45 CAT6A S/FTP LSZH BK 1M	1	Black
2311003595	PCORD RJ45 CAT6A S/FTP LSZH BU 1M	1	Blue
2311001240	PCORD RJ45 CAT6 S/FTP LSZH GY 2M	2	Grey
2311001253	PCORD RJ45 CAT6A S/FTP LSZH GN 2M	2	Green
2311001254	PCORD RJ45 CAT6A S/FTP LSZH RD 2M	2	Red
2311001265	PCORD RJ45 CAT6A S/FTP LSZH YE 2M	2	Yellow
2311001269	PCORD RJ45 CAT6A S/FTP LSZH BK 2M	2	Black
2311003596	PCORD RJ45 CAT6A S/FTP LSZH BU 2M	2	Blue
2311001241	PCORD RJ45 CAT6 S/FTP LSZH GY 3M	3	Grey
2311001258	PCORD RJ45 CAT6A S/FTP LSZH RD 3M	3	Red
2311001259	PCORD RJ45 CAT6A S/FTP LSZH YE 3M	3	Yellow
2311001262	PCORD RJ45 CAT6A S/FTP LSZH GN 3M	3	Green
2311001270	PCORD RJ45 CAT6A S/FTP LSZH BK 3M	3	Black
2311001313	PCORD RJ45 CAT6A S/FTP LSZH BU 3M	3	Blue
2311001256	PCORD RJ45 CAT6 S/FTP LSZH GY 5M	5	Grey
2311001261	PCORD RJ45 CAT6A S/FTP LSZH RD 5M	5	Red
2311001263	PCORD RJ45 CAT6A S/FTP LSZH GN 5M	5	Green
2311001266	PCORD RJ45 CAT6A S/FTP LSZH YE 5M	5	Yellow
2311001267	PCORD RJ45 CAT6 S/FTP LSZH GY 10M	10	Grey
2311003980	PCORD RJ45 CAT6A S/FTP LSZH RD 10M	10	Red
2311004205	PCORD RJ45 CAT6A S/FTP LSZH YE 10M	10	Yellow

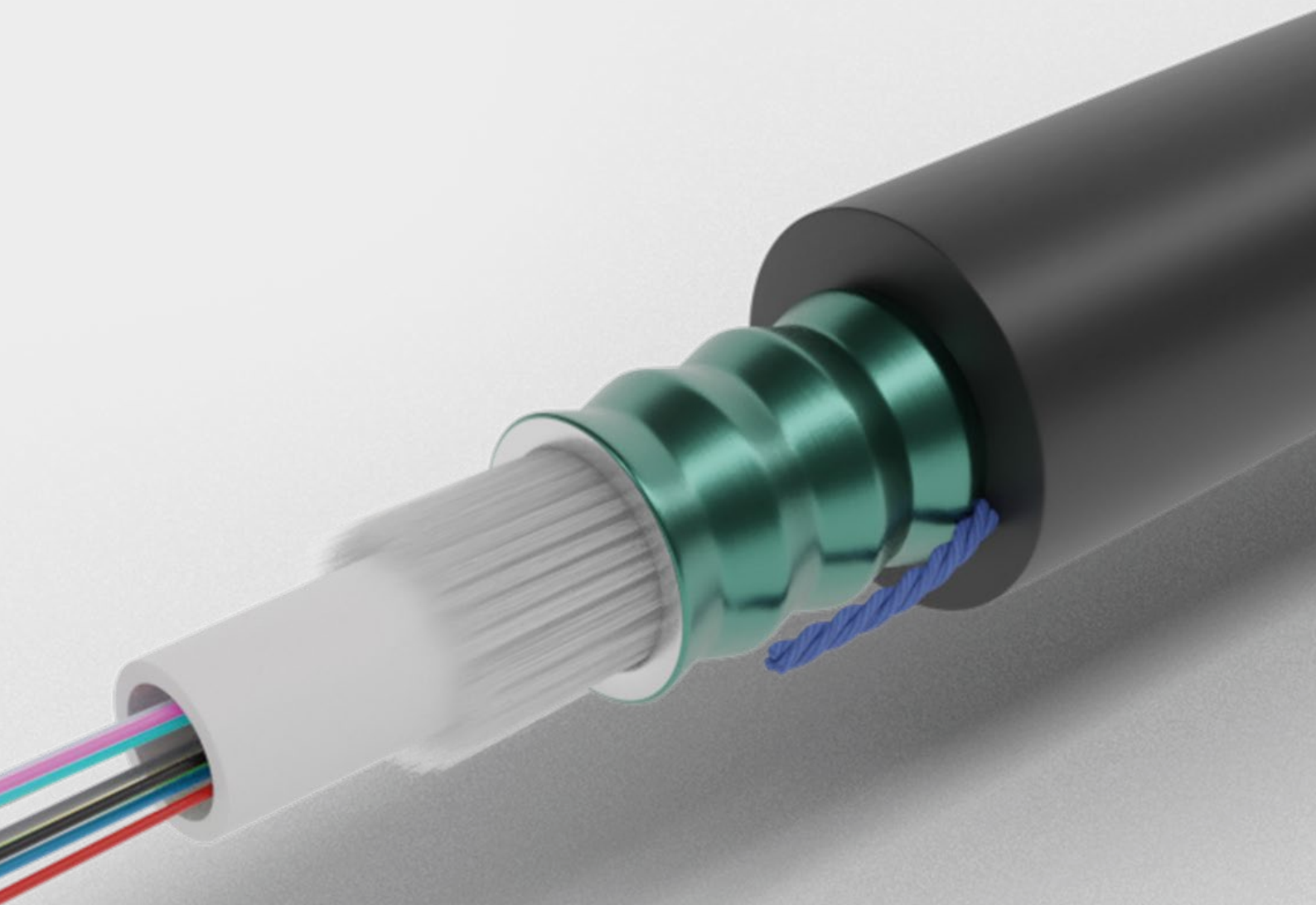

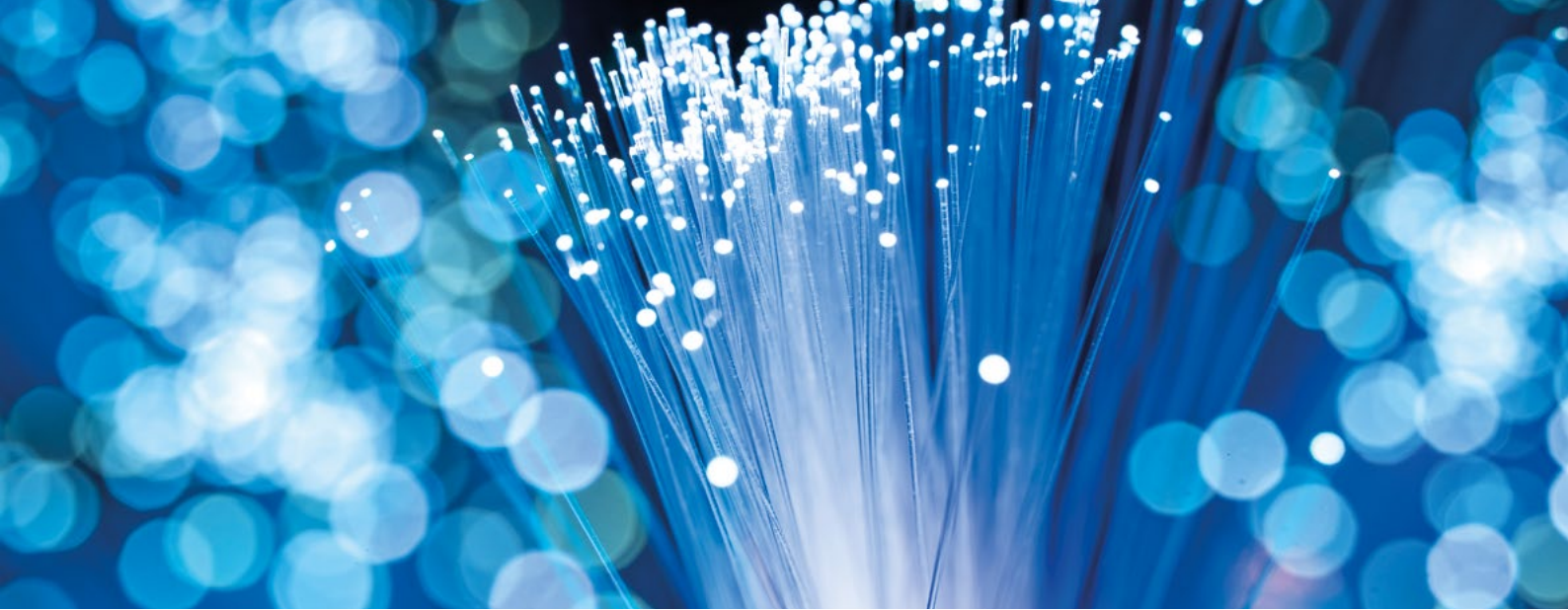

FIBER OPTIC SOLUTION

FIBER OPTIC SOLUTION	42
FIBER OPTICS	43
FIBER OPTIC CABLES	44
FIBER OPTIC CABLES OVERVIEW	45
FO CABLE ZIPCORD I-V(ZN)H	46
FO CABLE CAS J-V(ZN)H	47
FO CABLE R105 J-V(ZN)H(ZN)H	48
FO CABLE UNIVERSAL U-DQ(ZN)BH	49
FO CABLE MULTITUBE UNIVERSAL U-DQ(ZN)BH	51
FO CABLE DP A-DQ(ZN)B2Y (Outdoor Unitube)	53
FO CABLE DP A-DQ(ZN)B2Y (Outdoor Multitube)	55
FO CABLE DSP01 METALLIC ARMOURED A-DQ(ZN)(SR)2Y	57
FO CABLE DSP METALLIC ARMOURED A-DQ(ZN)(SR)2Y	59
FO CABLE PDP A-DQ 2Y(ZN)2Y	61
FO CABLE DPSP A-DQ(ZN)2Y(SR)2Y	62
FO CABLE HYBRID	63

FIBER OPTIC SOLUTION

An optical fiber is no more than a transmission guide for an optical signal that allows communication between two points.

Advantages of using Fiber:

- Immune to external interferences
- Cost effective
- Support large amounts of information
- High distances
- Less space and low weight

In a fiber optic cable there may be the following **types of optical fibers**:

- GOF (Glass optical Fiber) - most common fiberglass, with core 9/125; 62.5 / 125 or 50/125µm.
- POF (Polymer Optical Fiber) - the so-called plastic fiber with a core of 980/1000µm.
- PCF (Polymer Cladded Fiber) - Fiber with a core of 200/230µm.

FIBER OPTICS

The choice of fiber type will depend on the application, the distance and the desired transmission speed (Bandwidth), as shown in the table below:

Fiber Type	Application	Max. Working distance		Typ. Max. Attenuation (dB/Km): ^{d)}			
		@1Gbps	@10Gbps	@650nm	@850nm	@1310nm	@1550nm
OM1 (62,5/125)	Less used, Utilities or electricity networks	275M ^{a)}	33M ^{c)}	NA	< 2.5	< 0.7	NA
OM2 (50/125)	Enterprise Networks	550M ^{a)}	82M ^{c)}	NA	< 2.5	< 0.7	NA
OM3 (50/125)	Enterprise Networks	800M ^{a)}	300M ^{c)}	NA	< 2.5	< 0.7	NA
OM4 (50/125)	Data Centers	1100M ^{a)}	550M ^{c)}	NA	< 2.5	< 0.7	NA
OM5 (50/125)	Data Centers	1100M ^{a)}	550M ^{c)}	NA	< 2.5	< 0.7	NA
SM (9/125)	High distances, Telecom Operators	>100km	>100km	NA	NA	< 0.35	< 0.21
PCF (200/230)	Industry, profinet systems	50M ^{b)}		10	8		
POF (980/1000)	Industry, profinet systems	100M ^{b)}		16			

a) Considering operation @ 1Gbps (1000Base-SX)

b) Considering operating @100Mbps

c) Considering operation '@ 10Gbps (10GBase-SR /SW)

d) Fiber attenuation always depends on the wavelength used and the number of existing fusions.

The wavelength λ (lambda) is given by $\lambda = C / f$ where C is the velocity of the light in the vacuum (300000km/s) and f the frequency.

According to the ITU-T, some variants of single-mode optical fibers (SM-Singlemode) are also defined, such as:

Fiber Optic SM (Singlemode)	
Type	Specification
G.652D	Are the most used in the market, supports bend radius up to 30mm without attenuation.
G.657A1	Supports bend radius of 10mm without added attenuation.
G.657A2	Supports bend radius of 7,5mm without added attenuation.
G.657B2	Supports bend radius of 7,5mm without added attenuation.
G.657B3	Supports bend radius of 5mm without added attenuation.
G.655	Fiber with low attenuation compared with G652D. Allow high distances single mode fiber. With non-zero dispersion shifted (NZDSF) for CWDM and DWDM Systems (Dense Wave Division Multiplexing).

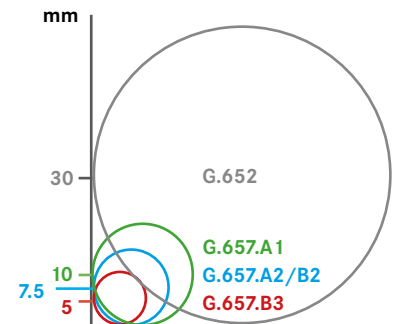

Fiber optic MM (Multimode)		
Type	Bandwith (Mhz/km)	
	@850nm	@1300nm
OM1	>=160nm	>=500
OM2	>=500	>=500
OM3	>=1500	>=500
OM4	>=3500	>=500
OM5	>=3500	>=500

FIBER OPTIC CABLES

The selection of the cable, besides the type of the fibers depends, also on the application that we want to give to the cable:

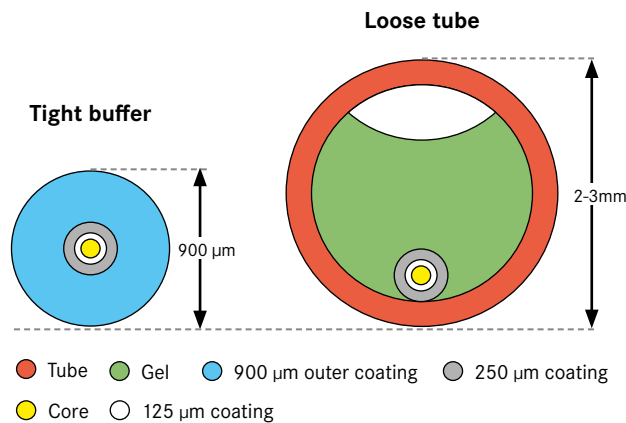
Tight buffer vs. Loose tube**Types of Armour**

Material	Construction	Weight	Flexibility	Rodent Protection
Steel (Metalic Armour)	Corrugated Steel	Medium	Medium	High
	Wire Armour (SWA)	High	High	High
	Screened	Medium	High	High
Fiber Glass (Dielectric Armour)	Longitudinal	Low	High	Medium
	Screened	Low	High	High

Fibers Identification Codes

Inside the cable the fibers are identified by colors.

According to:	IEC 60304/VDE08888	TIA 598-C
Fiber n.	Color	Color
1	Red	Blue
2	Green	Orange
3	Blue	Green
4	Yellow	Brown
5	White	Grey
6	Grey	White
7	Brown	Red
8	Violet	Black
9	Aqua	Yellow
10	Black	Violet
11	Orange	Pink
12	Pink	Aqua
13-24	Repeat the same sequence with black stripe	

FIBER OPTIC CABLES OVERVIEW

Cable Name	DIN/VDE 0888	NP922	Application	Rodent Protection	For Indoor	For Outdoor	Water Protection	UV Protection
Indoor & Universal								
Zipcord	I-V(ZN)H	TOC ZaZ1 T2 ...	Patch cords duplex		X			
CAS	I-V(ZN)H	TOC ZaZ1 T ...	FTTH drop cable, Patch cords		X			
R105	U-V(ZN)H(ZN)H	TOC ZaZ1ZaZ1 T...	FTTH drop cable, Patch cords		X	X		X
Breakout	I-V(ZN)H	TOC ZaZ1 T ...	Minibreakout cable, multiple fiber connections in small space		X	X		
Universal	U-DQ(ZN)BH	TOU ZvZ1 L... TON ZvZ1 L...	Versatile application for indoor or outdoor in ducts or pipes	X	X	X		X
Outdoor								
DP	A-DQ(ZN)B2Y	TOU ZvE L... TON ZvE L...	Outdoor applications in ducts or pipes	X		X		X
DSP	A-DQ(ZN)(SR)2Y	TOU ZrE L... TON ZrE L...	Outdoor applications in ducts or pipes with stronger rodent protection	X		X		X
PDP	A-DQ 2Y(ZN)B2Y	TOU EZvE L... TON EZvE L...	Outdoor applications in ducts or pipes with stronger rodent protection	X			X	
DPSP	A-DQ(ZN)2Y(SR)2Y	TOU ZvEZrE L... TON ZvEZrE L...	Outdoor applications in ducts or pipes with stronger rodent protection in harsh environments	X				
Hybrid	Hybrid A-DQ(ZN)B2Y	TOU ZvE L... TON ZvE L...	Outdoor fibre optic with 2 or 3 power conductors	X		X		X

Indoor Cables

Cables to be installed indoor. They are built with external sheath that does not produce halogens neither smoke in case of fire. Typically have smaller thickness since it does not have armor.

Universal Cables

Cables to be installed indoor or outdoor. They are built with external sheath that does not produce halogens neither smoke in case of fire, but they normally have an armor that gives them protection against rodents.

Outdoor Cables

Cables to be installed only outdoor. They are built with an external robust sheath, typically made of PE. Normally always have an armor that can be dielectric or metallic, that gives better protection against rodents. The outdoor cables can also have double sheath for extra protection against moisture or water.

FO Cable ZIPCORD I-V(ZN)H

Indoor tight buffer (up to 2 FO)

**Application**

Fiber optic cable for indoor applications for jumper and pigtail connections or direct connection using connectors to terminal devices.

Standards

- EN 60793-1-x,
- IEC 60332-1,
- IEC 61034-2,
- IEC 60793-2,
- IEC 60794-1-2,
- IEC 60794-1-21 E1/E3/E11,
- IEC 60794-1-22 F1
- EN 187000:1992,
- ISO/IEC 11801,
- ISO/IEC 24702

Design

1. Tight buffer duplex (0.9 mm)
2. Strength members
3. Outer jacket

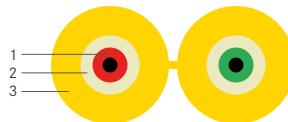
**Product Specifications**

Fiber Number	2
Strength Members	Aramid Yarns
Outer Jacket	Low Smoke, Low Halogen, Heavy Metals Free, Thermoplastic
Color	Depends on fiber type: ORANGE (RAL 2003) OM1/ BLUE (RAL 5015) OM2 / AQUA (RAL 6027) OM3 / VIOLET (RAL 4003) OM4 / LIME OM5 / YELLOW (RAL1021) OS-1/2 / BEIGE G657
Weight (Kg/Km)	15
Outer Diameter (mm)	2.8 x 5.7± 0.15
Max. Tensile Load (N)	1000 (Operation) / 700 (Installation)
Max. Crush (N/dm)	500
Temperature Range	-5°C to +60° C (Operating)
Min. Bending Radius	15 x Outer diameter
Maximum Length (m)	4000
Fiber Color	Red - Green

FO Cable CAS J-V(ZN)H

Drop FTTx



Application

Fiber optic cable tight buffer for FTTx networks, pigtail and jumper connections. For indoor installations, can be used outdoor if well protected (with black jacket). High flexibility and light weight.

Standards

- IEC 60794-1-2
- IEC 60794-1-21
- IEC 60794-1-22
- ISO/IEC 1180
- IEC 60332-1
- IEC 60754-1/-2

CPR

- DoP Number: PoliDoP026_00
- Class: D_{ca}-s₁,d₁,a₁

Design

1. Fibers (tight buffer)
2. Aramid
3. Jacket LSZH

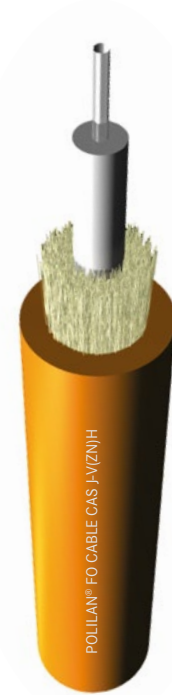
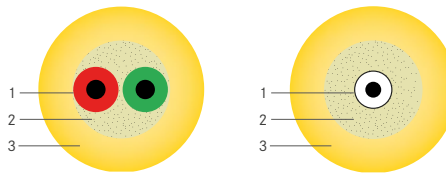

Product specifications				
Type Cable	CAS100	CAS105	CAS110	CAS115
Number Fibers	1	2	1	2
Buffer diameter (mm)	0.9	0.6	0.9	0.9
Strength Members	Aramid threads			
Jacket	LSZH			
Jacket Color	Ivory or Black (UV resistant)			
Weight (Kg/Km)	7	7	14	14
Outer Diameter (mm)	2.9 ± 0.15	2.9 ± 0.15	3.6 ± 0.1	3.6 ± 0.1
Max. Tensile Load Perm. / Inst. (N)	200 / 350	200 / 350	350 / 650	350 / 650
Max. Crush (N/100mm)	500	500	700	700
Temperature Range	-10°C a +70°C (IEC 60794-1-22 F1)			
Min. Bending Radius	5 x Outer Diameter (IEC 60794-1-21 E11)			

Article number	Description	Type	N° Fibers	Jacket color
2311001132	FO CAS100 1X G657A1	G657A1	1	Ivory
2311001121	FO CAS105 2X G657A1	G657A1	2	Ivory
2311001150	FO CAS115 2X G657A1	G657A1	2	Ivory
2311003042	FO CAS115 2X G657A1	G657A1	2	Black

FO Cable R105 J-V(ZN)H(ZN)H

Drop FTTx



Application

Fiber optic cable tight buffer for FTTx networks, pigtail and jumper connections. With double layer gives extra protection and strength to the fiber.

For indoor installations, can be used outdoor if well protected (with black jacket).

High flexibility and light weight.

Standards

- IEC 60794-1-2
- IEC 60794-1-21
- IEC 60794-1-22
- ISO/IEC 1180
- IEC 60332-1
- IEC 60754-1/-2

CPR

- DoP Number: PoliDoP033_00
- Class: D_{ca}-s₁,d₁,a₁



Design

1. Fibers (tight buffer)
2. Aramid
3. Inner jacket LSZH
4. Aramid
5. Outer jacket LSZH

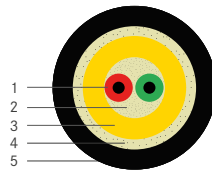

Product specifications

Type Cable	R105
Number Fibers	2
Buffer diameter (mm)	0,6
Strength Members	Aramid yarns
Inner Jacket	LSZH (Color Ivory)
Outer Jacket	LSZH (Color Black)
Weight (Kg/Km)	21
Outer Diameter (mm)	4.6 ± 0.2
Max. Tensile Load Perm. / Inst. (N)	550 (Operating) / 900 (Installation)
Max. Crush (N/100mm)	800 (IEC 60794-1-21 E3)
Temperature Range	-10°C to +70°C (IEC 60794-1-22 F1)
Min. Bending Radius	5 x Outer Diameter (IEC 60794-1-21 E11)

Article number	Description	Type	N° Fibers	Jacket color
2311001152	FO R105 2X G657A1 POLILAN	G657A1	2	Black

FO Cable Universal U-DQ(ZN)BH

Unitube (up to 24 FO)



Application

Fiber optic cable for indoor and outdoor applications with dielectric armour.

- Rodent protected
- Compact
- Lightweight
- Flexible
- Tough
- Resistant
- Watertight
- Totally dielectric
- Reduced diameter

Standards

- Flame retardant (IEC 60332-3)
- Halogen free (IEC 60754-1/-2)
- Low smoke emission (IEC 61034-1/-2)
- Mechanical and Environmental tests according to EN187000 and IEC 60794-1-2.
- EN 60793-2-50; EN 60794-1-1; EN 60793-1

CPR

- DoP Number: PoliDoP023_00
- Class: D_{ca}-S₂,d₂,a₁

Design

1. Fiber optics
2. Central tube (jelly filled)
3. Strength members
4. Ripcord
5. Outer jacket (LSZH)

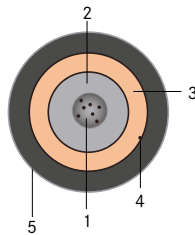

Product Specifications		
Fiber number	2 / 4 / 6 / 8 / 12	16 / 24
Central Tube (mm)	3.5 ± 0.2	4.2 ± 0.2
Strength members	Reinforced Fiberglass yarns WB (Waterblocking)	
Outer jacket	Thermoplastic LSZH	
Colour	Black	
Weight (Kg/Km)	53	60
Outer diameter (mm)	7.2 ± 0.3	7.9 ± 0.3
Max. Tensile Load (N)	1000 (Operating) / 1800 (Installation)	
Max. Crush (N/dm)	1500	
Temperature Range	-30°C to +70° C (Operating)	
Min. Bending Radius	20 x Outer diameter	
Maximum Length (m)	4000	
Fiber Color	Red - Green - Blue - Yellow - Grey - Violet - Brown - Orange - White - Pink - Black - Turquoise. With black stripe: Red - Green - Blue - Yellow - Grey - Violet - Brown - Orange - White - Pink - Natural - Turquoise	

FO Cable Universal U-DQ(ZN)BH Unitube (up to 24 FO)

Article number	Description	Type	N° Fibers
2311001124	FO UNIVERSAL 4X 9/125 SM	9/125 SM	4
2311004352	FO UNIVERSAL 6X 9/125 SM	9/125 SM	6
2311004353	FO UNIVERSAL 8X 9/125 SM	9/125 SM	8
2311001125	FO UNIVERSAL 12X 9/125 SM	9/125 SM	12
2311004354	FO UNIVERSAL 16X 9/125 SM	9/125 SM	16
2311004355	FO UNIVERSAL 24X 9/125 SM	9/125 SM	24
2311004341	FO UNIVERSAL 4X 50/125 OM4 POLILAN	OM4	4
2311004342	FO UNIVERSAL 6X 50/125 OM4 POLILAN	OM4	6
2311004343	FO UNIVERSAL 8X 50/125 OM4 POLILAN	OM4	8
2311004344	FO UNIVERSAL 12X 50/125 OM4 POLILAN	OM4	12
2311004345	FO UNIVERSAL 16X 50/125 OM4 POLILAN	OM4	16
2311004346	FO UNIVERSAL 24X 50/125 OM4 POLILAN	OM4	24
2311004332	FO UNIVERSAL 4X 50/125 OM3	OM3	4
2311004333	FO UNIVERSAL 6X 50/125 OM3 POLILAN	OM3	6
2311001126	FO UNIVERSAL 8X 50/125 OM3 POLILAN	OM3	8
2311001127	FO UNIVERSAL 12X 50/125 OM3 POLILAN	OM3	12
2311004334	FO UNIVERSAL 16X 50/125 OM3 POLILAN	OM3	16
2311004335	FO UNIVERSAL 24X 50/125 OM3 POLILAN	OM3	24

FO Cable Multitube Universal U-DQ(ZN)BH

Multitube (up to 144 FO)



Application

Fiber optic cable for indoor and outdoor applications with dielectric armour.

- Rodent protected
- Compact
- Lightweight
- Flexible
- Tough
- Resistant
- Watertight
- Totally dielectric
- Reduced diameter
- Multitube

Standards

- Flame retardant (IEC 60332-3 / IEC 60332-3)
- Halogen free (IEC 60754-1/-2)
- Low smoke emission (IEC 61034-1/-2)
- Mechanical and Environmental tests according to EN187000 and IEC 60794-1-2.
- EN 60793-2-50; EN 60794-1-1; EN 60793-1

CPR

- DoP Number: PoliDoP030_00
- Class: D_{ca}-s₂,d₂,a₁

Design

1. Central element (GRP)
2. Fiber optics
3. Loose tube (jelly field)
4. Fiberglass Reinforcements—WB
5. Ripcord
6. Outer jacket (LSZH)

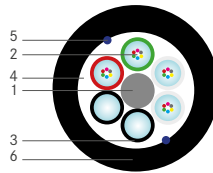

Product Specifications										
Fiber Count	16	24	32	36	48	64	72	96	128	144
Fiber per Tube	4	6	8	6	12	8	12	12	8	12
Total Tubes	4	4	4	6	4	8	6	8	18	12
Active Tubes	4	4	4	6	4	8	6	8	16	12
Strength Members	Reinforced Fiberglass Yarns WB (Waterblocking)									
Outer Jacket	LSZH*—Dark Grey									
Colour	Black									
Weight (Kg/Km)	76	76	89	97	102	154	137	178	217	200
Outer Diameter (mm ±0.5)	8.8	8.8	9.8	10.0	10.5	12.7	12.1	13.8	16.2	14.0
Max. Tensile Load (N)	1000 (Operation) / 1800 (Installation)					1500 (Operation) / 2700 (Installation)				
Max. Crush (N/dm)	2000 (IEC 60794-1-21 E3)									
Max. Impact (J)	5 (IEC 60794-1-21 E4)									
Temperature Range	-30°C to +70°C (Operating) / -10°C to +50°C (Installation) - (IEC 60794-1-22 F1)									
Min. Bending Radius	15 x Outer diameter (Operating) / 20 x Outer diameter (Installation) - (IEC 60794-1-21 E11)									
Water tightness	According (3m, 1m, 24h, Optical Core, IEC 60794-1-22 F5B)									
Maximum Length (m)	4200	4200	3100	4200	2100	3100	2100	2100	3100	2100

*LSZH - Halogen free, low smoke and flame retardant thermoplastic compound.

FO Cable Multitube Universal U-DQ(ZN)BH Multitube (up to 144 FO)

Article number	Description	Type	N° Fibers
2311004356	FO UNIVERSAL (3x12)36X 9/125 SM POLI	9/125 SM	36
2311004357	FO UNIVERSAL (4x12)48X 9/125 SM POLI	9/125 SM	48
2311004358	FO UNIVERSAL (6x12)72X 9/125 SM POLI	9/125 SM	72
2311004359	FO UNIVERSAL (8x12)96X 9/125 SM POLI	9/125 SM	96
2311004360	FO UNIVERSAL (12x12)144X 9/125 SM POLI	9/125 SM	144
2311004347	FO UNIVERSAL (3x12)36X 50/125 OM4 POLI	50/125 OM4	36
2311004348	FO UNIVERSAL (4x12)48X 50/125 OM4 POLI	50/125 OM4	48
2311004349	FO UNIVERSAL (6x12)72X 50/125 OM4 POLI	50/125 OM4	72
2311004350	FO UNIVERSAL (8x12)96X 50/125 OM4 POLI	50/125 OM4	96
2311004351	FO UNIVERSAL (12x12)144X 50/125 OM4 POLI	50/125 OM4	144
2311004336	FO UNIVERSAL (3x12)36X 50/125 OM3 POLI	50/125 OM3	36
2311004337	FO UNIVERSAL (4x12)48X 50/125 OM3 POLI	50/125 OM3	48
2311004338	FO UNIVERSAL (6x12)72X 50/125 OM3 POLI	50/125 OM3	72
2311004339	FO UNIVERSAL (8x12)96X 50/125 OM3 POLI	50/125 OM3	96
2311004340	FO UNIVERSAL (12x12)144X 50/125 OM3 POLI	50/125 OM3	44

FO Cable DP A-DQ(ZN)B2Y

Outdoor Unitube (up to 24 FO)



Application

Fiber optic cable for outdoor applications with dielectric armour.

- Rodent protected
- Compact
- Lightweight
- Flexible
- Tough
- Resistant
- Watertight
- Reduced diameter
- Excellent resistance to friction
- Suitable for “blown air” system

Standards

- Mechanical and environmental tests according to IEC 60794-1-21 and IEC 60794-1-22.
- EN 60793-2-50; EN 60794-1-1; EN 60793-1

CPR

- DoP Number: PoliDoP050_00
- Class: F_{ca}



Design

1. Fiber optics
2. Central tube (jelly field)
3. Fiberglass Reinforcements - WB
4. Ripcord
5. Outer jacket

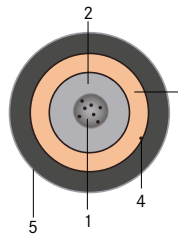

Product Specifications		
Fiber Number	2 / 4 / 6 / 8 / 12	16 / 24
Central Tube (mm)	3.5 ± 0.2	4.2 ± 0.2
Strength Members	Reinforced Fiberglass Yarns WB (Waterblocking)	
Outer Jacket	High Density Polyethylene (HDPE)	
Colour	Black	
Weight (Kg/Km)	40	50
Outer Diameter (mm)	7.2 ± 0.3	7.9 ± 0.3
Max. Tensile Load (N)	1000 (Operation) / 1800 (Installation) - (IEC 60794-1-21 E1)	
Max. Crush (N/dm)	2000 (IEC 60794-1-21 E3)	
Max. Impact (J)	5 (IEC 60794-1-21 E4)	
Temperature Range	-40°C to +70°C (Operating) / -10°C to +50°C (Installation) - (IEC 60794-1-22 F1)	
Min. Bending Radius	15 x Outer diameter (Operating) / 20 x Outer diameter (Installation) - (IEC 60794-1-21 E11)	
Maximum Length (m)	4000	
Fibers Color	Red - Green - Blue - Yellow - Grey - Violet - Brown - Orange - White - Pink - Black - Turquoise. With black stripe: Red - Green - Blue - Yellow - Grey - Violet - Brown - Orange - White - Pink - Natural - Turquoise.	

FO Cable DP A-DQ(ZN)B2Y Outdoor Unitube (up to 24 FO)

Article number	Description	Fiber Type	N° Fibers
2311004428	FO DP 4X 9/125 SM POLILAN	9/125 SM	4
2311004429	FO DP 6X 9/125 SM POLILAN	9/125 SM	6
2311004430	FO DP 8X 9/125 SM POLILAN	9/125 SM	8
2311004431	FO DP 12X 9/125 SM POLILAN	9/125 SM	12
2311004432	FO DP 16X 9/125 SM POLILAN	9/125 SM	16
2311004433	FO DP 24X 9/125 SM POLILAN	9/125 SM	24
2311004417	FO DP 4X 50/125 OM4 POLILAN	50/125 OM4	4
2311004418	FO DP 6X 50/125 OM4 POLILAN	50/125 OM4	6
2311004419	FO DP 8X 50/125 OM4 POLILAN	50/125 OM4	8
2311004420	FO DP 12X 50/125 OM4 POLILAN	50/125 OM4	12
2311004421	FO DP 16X 50/125 OM4 POLILAN	50/125 OM4	16
2311004422	FO DP 24X 50/125 OM4 POLILAN	50/125 OM4	24
2311004406	FO DP 4X 50/125 OM3 POLILAN	50/125 OM3	4
2311004407	FO DP 6X 50/125 OM3 POLILAN	50/125 OM3	6
2311004408	FO DP 8X 50/125 OM3 POLILAN	50/125 OM3	8
2311004409	FO DP 12X 50/125 OM3 POLILAN	50/125 OM3	12
2311004410	FO DP 16X 50/125 OM3 POLILAN	50/125 OM3	16
2311004411	FO DP 24X 50/125 OM3 POLILAN	50/125 OM3	24

FO Cable DP A-DQ(ZN)B2Y

Outdoor Multitube (up to 144 FO)



Application

Fiber optic cable for outdoor applications with excellent mechanical resistance, totally dielectric.

- Rodent protected
- Excellent resistance to friction
- Excellent mechanical resistance
- Able to be blown
- Construction: A-DQ(ZN)2Y
- Reaction to Fire: F_{ca}

Standards

- Mechanical and Environmental tests according to IEC 60794-1-21 and IEC 60794-1-22.
- EN 60793-2-50; EN 60794-1-1; EN 60793-1

CPR

- DoP Number: PoliDoP051_00
- Class: F_{ca}



Design

1. Central element (GRP)
2. Fiber optics
3. Loose tube (jelly field)
4. Strength Members
5. Ripcord
6. Outer jacket

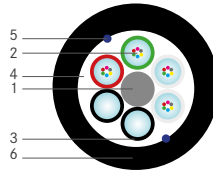

Product Specifications										
Fiber Count	16	24	32	36	48	64	72	96	128	144
Fiber per Tube	4	6	8	6	12	8	12	12	8	12
Total Tubes	4	4	4	6	4	8	6	8	18	12
Active Tubes	4	4	4	6	4	8	6	8	16	12
Strength Members	Reinforced Fiberglass Yarns WB (Waterblocking)									
Outer Jacket	Polyethylene									
Color	Black									
Weight (Kg/Km)	58	58	69	76	80	127	111	148	181	165
Outer Diameter (mm ±0.5)	8.8	8.8	9.8	10.0	10.5	12.7	12.1	13.8	16.2	14.0
Max. Tensile Load (N)	1000 (Operation) / 1800 (Installation)					1500 (Operation) / 2700 (Installation)				
Max. Crush (N/dm)	2000 (IEC 60794-1-21 E3)									
Max. Impact (J)	5 (IEC 60794-1-21 E4)									
Temperature Range	-40°C to +70°C (Operating) / -10°C to +50°C (Installation) - (IEC 60794-1-22 F1)									
Min. Bending Radius	15 x Outer diameter (Operating) / 20 x Outer diameter (Installation) - (IEC 60794-1-21 E11)									
Water tightness	According (3m, 1m, 24h, Optical Core, IEC 60794-1-22 F5B)									
Maximum Length (m)	4200	4200	3100	4200	2100	3100	2100	2100	3100	2100
Fibers Color Code	Red - Green - Blue - Yellow - Grey - Violet - Brown - Orange - White - Pink - Black - Turquoise									
Tubes Color code	Red - Green - Natural... - Natural. Passive tubes color Black.									

FO Cable DP A-DQ(ZN)B2Y

Outdoor Multitube (up to 144 FO)

Article number	Description	Type	N° Fibers
2311004434	FO DP (3X12)36X 9/125 SM POLI	9/125 SM	36
2311004435	FO DP (4X12)48X 9/125 SM POLI	9/125 SM	48
2311004436	FO DP (6X12)72X 9/125 SM POLI	9/125 SM	72
2311004437	FO DP (8X12)96X 9/125 SM POLI	9/125 SM	96
2311004438	FO DP (12X12)144X 9/125 SM POLI	9/125 SM	144
2311004423	FO DP (3X12)36X 50/125 OM4 POLI	50/125 OM4	36
2311004424	FO DP (4X12)48X 50/125 OM4 POLI	50/125 OM4	48
2311004425	FO DP (6X12)72X 50/125 OM4 POLI	50/125 OM4	72
2311004426	FO DP (8X12)96X 50/125 OM4 POLI	50/125 OM4	96
2311004427	FO DP (12X12)144X 50/125 OM4 POLI	50/125 OM4	144
2311004412	FO DP (3X12)36X 50/125 OM3 POLI	50/125 OM3	36
2311004413	FO DP (4X12)48X 50/125 OM3 POLI	50/125 OM3	48
2311004414	FO DP (6X12)72X 50/125 OM3 POLI	50/125 OM3	72
2311004415	FO DP (8X12)96X 50/125 OM3 POLI	50/125 OM3	96
2311004416	FO DP (12X12)144X 50/125 OM3 POLI	50/125 OM3	144

FO Cable DSP01 Metallic Armoured A-DQ(ZN)(SR)2Y Outdoor Unitube (up to 24 FO)



Application

Fiber optic cable for outdoor applications with metallic armour. Suitable installing in ducts, laying in cable platforms, cable shafts and even in complex cable trays, particularly where a reliable rodent protection is required.

Standards

- EN 60793-1-x
- IEC 60793-2
- IEC 60794-1-2
- EN 187 000:1992
- ISO/IEC 11801
- ISO/IEC 24702
- Mechanical and Environmental tests according to EN187000 and IEC 60794-1-2.

CPR

- DoP Number: PoliDoP039_00
- Class: F_{ca}

Design

1. Fiber optics
2. Central tube (jelly field)
3. Strength members
4. Metallic armour
5. Ripcord
6. Outer jacket (PE)

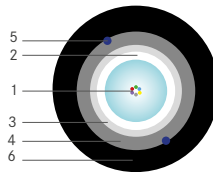

Product Specifications	
Fiber Number	2 / 4 / 6 / 8 / 12 / 16 / 24
Central Tube (mm)	4,5 ± 0.2
Strength Members	Reinforced Fiberglass Yarns WB (Waterblocking)
Armour	Corrugated Steel Armour
Outer Jacket	HD Polyethylene
Color	Black
Weight (Kg/Km)	88
Outer Diameter (mm)	9.6 ± 0.3
Max. Tensile Load (N)	1000 (Operation) / 1800 (Installation)
Max. Crush (N/dm)	2000
Temperature Range	-40°C to +70°C (Operating)
Min. Bending Radius	20 x Outer diameter
Maximum Length (m)	4000
Fiber Color	Red - Green - Blue - Yellow - Grey - Violet - Brown - Orange - White - Pink - Black - Turquoise. With black stripe: Red - Green - Blue - Yellow - Grey - Violet - Brown - Orange - White - Pink - Natural - Turquoise

FO Cable DSP-1 Metallic Armoured A-DQ(ZN)(SR)2Y Unitube (up to 24 FO)

Article number	Description	Type	N° Fibers
	FO DSP-1 2X 9/125 SM	SM G652D	2
	FO DSP-1 4X 9/125 SM	SM G652D	4
	FO DSP-1 6X 9/125 SM	SM G652D	6
2311001140	FO DSP-1 8X 9/125 SM	SM G652D	8
2311001162	FO DSP-1 12X 9/125 SM	SM G652D	12
	FO DSP-1 24X 9/125 SM	SM G652D	24
	FO DSP-1 4X 50/125 SM	OM4	4
	FO DSP-1 6X 50/125 SM	OM4	6
	FO DSP-1 8X 50/125 SM	OM4	8
	FO DSP-1 12X 50/125 SM	OM4	12
	FO DSP-1 24X 50/125 SM	OM4	24
2311001130	FO DSP-1 4X 62,5/125 OM1	OM1	4
2311001112	FO DSP-1 12X 50/125 OM2	OM2	12

FO Cable DSP Metallic Armoured A-DQ(ZN)(SR)2Y Outdoor Multitube (up to 144 FO)



Application

Fiber optic cable for outdoor applications with metallic armour. Suitable installing in ducts, laying in cable platforms, cable shafts and even in complex cable trays, particularly where a reliable rodent protection is required.

Standards

- EN 60793-1-x
- IEC 60793-2
- IEC 60794-1-2
- EN 187 000:1992
- ISO/IEC 11801
- ISO/IEC 24702
- Mechanical and Environmental tests according to EN187000 and IEC 60794-1-2.

CPR

- DoP Number: PoliDoP039_00
- Class: F_{ca}

Design

1. Central element (GRP)
2. Fiber optics
3. Loose tube (jelly field)
4. Strength members
5. Metallic armour
6. Ripcord
7. Outer jacket

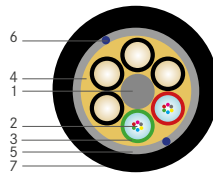

Product Specifications											
Fibers	12	16	24	32	36	48	64	72	96	128	144
Total Tubes	4	4	4	6	6	6	8	8	8	18	12
Active Tubes	2 or 3	2	2/3 or 4	4	3	4 or 6	8	6	8	16	12
Strength Members	Reinforced Fiberglass Yarns WB (Waterblocking)										
Armour	Corrugated Steel Armour										
Outer Jacket	HB Polyethylene										
Color	Black										
Weight (Kg/Km)	98	98	98	143	148	148	220	215	222	269	261
Outer Diameter (mm ±0.5)	10.0 ±0.5	10.0 ±0.5	10.0 ±0.5	12.5 ±0.5	12.5 ±0.5	12.5 ±0.5	15.5 ±0.5	15.5 ±0.5	15.5 ±0.5	18.0 ±0.5	18.0 ±0.5
Max. Tensile Load (N)	2000 (Permanent) / 3600 (Installation)										
Crush (N)	2500										
Temperature Range	-40°C to +70°C										
Min. Bending Radius	15 x Outer diameter (Service) / 20 x Outer diameter (Installation)										

FO Cable DSP Metallic Armoured A-DQ(ZN)(SR)2Y Outdoor Multitube (up to 144 FO)

Article number	Description	Type	N° Fibers
2311003785	FO DSP (2x6)12x 9/125 SM	SM G652D	12
	FO DSP (2x12)24x 9/125 SM	SM G652D	24
2311001141	FO DSP (4x12)48x 9/125 SM	SM G652D	48
	FO DSP (6x12)72x 9/125 SM	SM G652D	72
	FO DSP (16x8)128x 9/125 SM	SM G652D	128
2311089976	FO DSP (12x12)144x 9/125 SM	SM G652D	144
2311004621	FO DSP (4x6)24x 9/125 SM	SM G655	24
	FO DSP (2x6)12x 50/125 OM4	OM4	12
	FO DSP (2x12)24x 50/125 OM4	OM4	24
	FO DSP (4x12)48x 50/125 OM4	OM4	48
	FO DSP (6x12)72x 50/125 OM4	OM4	72
	FO DSP (16x8)128x 50/125 OM4	OM4	128
	FO DSP (12x12)144x 50/125 OM4	OM4	144

FO Cable PDP A-DQ 2Y(ZN)2Y

Outdoor Multitube Double Layer (up to 144 fibers)



Application

Fiber optic cable multitube loose for outdoor installation in ducts or direct burial. With non metallic armour it has excellent rodent protection.

Standards

- IEC 60794-1-2
- IEC 60794-1-21
- IEC 60794-1-22
- ISO/IEC 11801

CPR

- DoP Number: PoliDoP038_00
- Class: F_{ca}

Design

1. Central element (GRP)
2. Optical fibers
3. Loose tubes (jelly filled)
4. Water blocking elements
5. Ripcord
6. Inner jacket
7. Strength members
8. Outer jacket

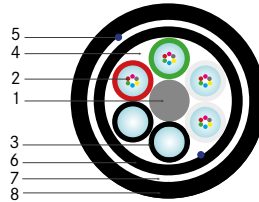

Product Specifications												
Fibers	12	16	24	32	36	48	64	72	96	128	144	
Fibers per Tube	12	8	12	8	12	12	8	12	12	8	12	
Total Tubes	6	6	6	6	6	6	8	6	8	18	12	
Active Tubes	1	2	2	4	3	4	8	6	8	16	12	
Strength Members	Reinforced Fiberglass Yarns WB (Waterblocking)											
Inner Jacket	Polyethylene - Black											
Outer Jacket	High Density Polyethylene - Black											
Weight (Kg/Km)	86	86	87	101	118	112	173	157	196	254	317	
Outer Diameter (mm ± 0.5)	10.5 ±0.5	10.5 ±0.5	10.5 ±0.5	11.5 ±0.5	12.1 ±0.5	12.1 ±0.5	14.5 ±0.5	14.0 ±0.5	15.5 ±0.5	18.5 ±0.5	19.5 ±0.5	
Max. Tensile Load (N)	1000 (Operating) / 1800 (Installation)								1500 / 2700			
Max. Crush (N/dm)	2500 (IEC 60794-1-21 E3)											
Watertightness	Yes (3m / 24h / 1m / Optical Core / IEC 60794-1-22 F5B)											
Temperature Range	-40°C to +70°C (IEC 60794-1-22 F1)											
Min. Bending Radius	20 x Outer diameter (IEC 60794-1-21 E11)											

FO Cable DPSP A-DQ(ZN)2Y(SR)2Y

Outdoor Multitube Metallic Armoured Double Layer (up to 144 fibers)

**Application**

Fiber optic cable multitube loose for outdoor installation in ducts or direct burial.

With strong metallic armour, it has excellent rodent protection.

Permanent shallow immersion in fresh and salt water.

Standards

- IEC 60794-1-2
- IEC 60794-1-21
- IEC 60794-1-22
- ISO/IEC 11801

CPR

- DoP Number: PoliDoP027_00
- Class: F_{ca}

**Design**

1. Central element (GRP)
2. Optical fibers
3. Loose tubes (jelly filled)
4. Strength members
5. Ripcord
6. Inner jacket
7. Metallic armour
8. Ripcord
9. Outer jacket

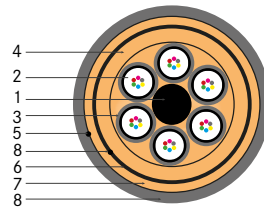
**Product Specifications**

	12	16	24	32	36	48	64	72	96	128	144
Fibers	12	16	24	32	36	48	64	72	96	128	144
Fibers per Tube	12	8	12	8	12	12	8	12	12	8	12
Total Tubes	6	6	6	6	6	6	8	6	8	18	12
Active Tubes	1	2	2	4	3	4	8	6	8	16	12
Strength Members	Reinforced Fiberglass Yarns WB (Waterblocking)										
Inner Jacket	Polyethylene - Black										
Armour	Corrugated Steel Armour										
Outer Jacket	Polyethylene - Black										
Weight (Kg/Km)	176	176	177	177	177	178	203	179	209	293	299
Outer Diameter (mm ± 0.5)	14.0 ±0.5	14.0 ±0.5	14.0 ±0.5	14.0 ±0.5	14.0 ±0.5	14.0 ±0.5	15.5 ±0.5	14.0 ±0.5	15.5 ±0.5	18.5 ±0.5	18.0 ±0.5
Max. Tensile Load (N)	1000 (Operating) / 1800 (Installation)									1500 / 2700	
Max. Crush (N/dm)	4000 (IEC 60794-1-21 E3)										
Watertightness	Yes (3m / 24h / 1m / Optical Core / IEC 60794-1-22 F5B)										
Temperature Range	-40°C to +70°C (IEC 60794-1-22 F1)										
Min. Bending Radius	20 x Outer diameter (IEC 60794-1-21 E11)										

FO Cable Hybrid

Fiber + Energy



Application

Fiber optic cable with stranded copper energy wires. Allow high bandwidth communication, plus the transport of energy. To feed surveillance cameras or hotspot wifi, or other remote device. To be used outdoor with rodent protection.

Standards

- ISO/IEC 11801
- EN 60793-1-x
- IEC 60793-2
- EN 60794-1-1
- EN 60793-2-50

Design

1. Fibers optics
2. Central filler with water blocking elements
3. Energy copper conductors
4. Fiber glass yarns
5. PE Sheath

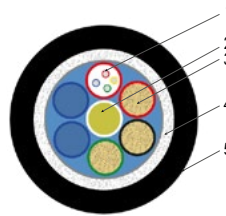

Electrical properties at 20°C

Conductor section (mm ²)	Max. conductor resistance (Ω/km)	Conductor material	Insulation material	Nominal voltage
1,5	12,1	Copper	PVC	0,6/1 kV
2,5	7,98	Copper	PVC	0,6/1 kV

Mechanical and environmental characteristics

Crush performance	2700 [N/ 10 cm]	IEC 60794-1-21-E3
Bending radius:	Static: 15 x D Dynamic: 20 x D	IEC 60794-1-21-E6
Water penetration:	3m sample, 1m head, 24h	IEC 60794-1-22-F5
Temperature Range	Installation: -15... +55 [°C] Operation: -40... +70 [°C]	IEC 60794-1-22-F1

Article number	Description	Application	Electrical conductors		Fiber optics	
			N° conductors	Section (mm ²)	N° Fibers	Type
2311090710	FO HYBRID	Outdoor	3	1,5	2	9/125 SM
2311090709	FO HYBRID	Outdoor	2	1,5	2	9/125 SM
2311090713	FO HYBRID	Outdoor	3	1,5	4	9/125 SM
2311090711	FO HYBRID	Outdoor	2	1,5	4	9/125 SM
2311090714	FO HYBRID	Outdoor	3	2,5	4	9/125 SM
2311090712	FO HYBRID	Outdoor	2	2,5	4	9/125 SM



FIBER OPTIC ACCESSORIES

PATCH PANEL FO - 24x SC/LC/E2000	66
FO BOX IP65 INDOOR/OUTDOOR	67
BOX FO 24x SC/LCD	68
PATCH PANEL FO DIN-RAIL	69
ENCLOSURE FIBER OPTIC DOME (UP TO 144 SPLICES)	70
FO BOX FTTH INDOOR	71
ADAPTER SC	72
ADAPTER ST	73
PIGTAIL FIBER OPTIC	74
PATCH CORD FIBER SINGLE MODE	75
PATCH CORD FIBER OPTIC ENHANCED OM3/MULTIMODE	77
PATCH CORD FIBER MULTIMODE	78
FIBRE OPTIC CONSUMABLES	79

Patch Panel FO - 24x SC/LCD/E2000

1U Sliding Patch Panel for 19" Racks



Description

This innovative, robust 1U sliding patch panel. This panel has been designed to accept up to 48 fibers housed within a 1U space. These panels include an internal mounting plate to install the adaptors giving a reduction in the bend radius of the exiting patch cords also giving a more aesthetically pleasing installation. With the ability to use a full array of adaptor types offering a flexible solution to the end user, enabling them to incorporate a multi-functional panel which allows easy access during installation or re-work with no disturbance of the existing cable or fibers.

In the addition to the array of adaptors, the panel also offers multiple cable entry solutions, up to 4 standard cable entry points for, loose tube, tight buffer, pre-terminated and steel tape armoured cable.

Each panel has integrated strength member tie positions also with the additional removable plate at the rear of the panel allows the installation of steel tape armoured cable.



Application

- Data centers, premise installations, telecommunication networks
- Ethernet, Fiber Channel, ATM, LAN, MAN and WAN
- Data communication
- Indoor applications

Features

- Up to 48 fibers in 1U
- Multiple adaptor options available
- 24 Adaptor positions
- Recessed adaptor positioning
- Individually labeled ports
- 45° open working angle
- Accepts loose tube, distribution and pre terminated cables
- RoHS, REACH SvHC and UL rated
- Fits standard 19"
- In Accordance with: TIA/EIA 568.C, ISSO/IEC 11801, EN50173, IEC60304, IEC61754

Other accessories may need:



Splice tray 24 fibers
PN 2311001009



Splice tray 12 fibers
PN 2311001000

Article number	Description	Adapters	Extras	Color
2311002072	PPANEL FO 24X LCD/SC 19" 1U W/CVRS BK	For LCD, SC, E2000 -not included	With covers	Black
2311002064	PPANEL FO 24X LCD/SC 19" 1U W/CVRS+TRY BK	For LCD, SC, E2000 -not included	With covers / With splice tray	Black
2311002063	PPANEL FO 24X SCD 19" 1U W/CVRS+TRY BK	For LC Quad, SCD, -not included	With covers / With splice tray	Black
2311002070	PPANEL FO 24X LCD/SC 19" 1U W/CVRS+TRY GY	For LCD, SC, E2000 -not included	With covers / With splice tray	Grey
2311002071	PPANEL FO 24X SCD 19" 1U W/CVRS+TRY GY	For LC Quad, SCD, -not included	With covers / With splice tray	Grey

Approved Trade Product, but no POLILAN product.

FO Box IP65 Indoor/Outdoor

4 Fibers – SC or LCD Connectors



Application

This fiber distribution box offers the ability to terminate 4 fibers housed in a robust ABS Enclosure for indoor and outdoor applications (IP65 protection index).

- Data centres, premise installations, telecommunication networks.
- Ethernet, Fiber Channel, ATM, LAN, MAN and WAN.
- Data communication and telecommunication networks.

Standards

- TIA/EIA 568.C,
- ISO/IEC 11801,
- EN50173,
- IEC60304,
- IEC61754,
- EN297-1



Features

- Support SC Simplex or LC Duplex connectors
- Removable/Hinged splice tray for easy installation
- 4 adapter positions
- IP 65
- Accepts loose tube, distribution and pre-terminated cables
- Sealing glands for up to 4 exiting cables + 1 incoming cable
- ROHS, REACH & SvHC compliant
- Supplied with 4 heat shrink splice protectors
- Supplied with wall fixings

Product Specifications	
N° fibers	4 (any type)
Cable entry / Cable exit	1/4
Material	ABS
Color	White/Grey
Operating temperature (°C)	-40°C to +60°C
Dimension	217mm (Height) x 145mm (Width) x 40mm (Depth) ; 220mm x 150mm x 47mm (packaged)
Weight	0,44kg (0,52 kg packaged)

Article number	Description	N° Fibers	Connectors
2311001057	BOX FO W37 4XL CD/SC IP65	4	SC or LCD

Approved Trade Product, but no POLILAN product.

POLILAN®

Box FO 24x SC/LCD IP65 Indoor/Outdoor



Application

This fiber distribution box offers the ability to terminate 24 fibers housed in a robust ABS Enclosure for indoor and outdoor applications (IP65 protection index).

- Data centres, premise installations, telecommunication networks.
- Ethernet, Fiber Channel, ATM, LAN, MAN and WAN.
- Data communication and telecommunication networks.

Standards

- TIA/EIA 568.C,
- ISO/IEC 11801,
- EN50173,
- IEC60304,
- IEC61754,
- EN297-1



Features

- Support SC Simplex or LC Duplex connectors
- Lockable door for added security
- Removable splice tray for easy installation
- Integrated cable tie points for securing incoming cable
- IP 65
- Accepts loose tube, distribution and pre-terminated cables
- Sealing glands for up to 24 exiting cables + 2 incoming cable
- ROHS, REACH & SvHC compliant
- Supplied with 24 heat shrink splice protectors + transit tube
- Supplied with wall fixings and tie wraps

Product Specifications

Product Specifications	
N° fibers	24 (any type)
Cable entry / Cable exit	2/24
Material	ABS
Color	Grey RAL 7035
Operating temperature (°C)	-40°C to +60°C
Dimension	340 mm(Height) x 27 0mm (Width) x 110 mm (Depth)
Weight	1,8 kg net

Article number	Description	N° Fibers	Connectors
2311001049	BOX FO W31 24XL CD/SC IP65	24	SC or LCD

Approved Trade Product, but no POLILAN product.

Patch Panel FO Din-Rail

Industrial Fiber Optic Patch Panel for Din-Rail



Application

Fiber optic industrial patch panel for din-rail. To be used in switchboards where it is needed to terminate fiber optic cable.

Included:

- Housing for DIN-Rail mounting (with DIN-Rail clip)
- Integrated splice cassette
- Splice holder for 12 crimp splices
- 1 x cable gland M20

Delivery unassembled and without Front Panel.



Design

- Dimensions: 61x115x113 mm (Width x Height x Depth)
- Material: Metal and Aluminium
- Color: Grey (RAL 7035)
- Cable can entry from top or bottom (one M20 cable gland is included)

Additional components (not included):

Front Panels:

(one should be selected):

- Front plate 6 x SC duplex
- Front plate 6 x SC simplex
- Front plate 12 x SC simplex
- Front plate 12x ST simplex



Adapters:

(please check the datasheet)



Pigtails:

(please check the datasheet)



Article number	Description
2311001191	PPANEL FO DIN-RAIL INDUSTRIAL WO/FPLATE
Front Panels:	
2311001194	PPANEL FPLATE 12XLCD/SC DIN-RAIL
2311001193	PPANEL FPLATE 6XLCD/SC DIN-RAIL
2311001192	PPANEL FPLATE 6XSCD DIN-RAIL
2311003692	PPANEL FPLATE 12XST DIN-RAIL

Approved Trade Product, but no POLILAN product.

Enclosure Fiber Optic DOME (up to 144 splices)

IP68 Outdoor



Application

The DOME enclosure is suitable for protecting fiber cable splices in branching applications. Its well-engineered, injection-moulded outer body makes it impenetrable to the elements. It can protect splices and ensure reliability. It can be placed in aerial, wall mounted, or duct mounted locations.

Specifications

- Up to 144 fibers
- Easy entrance of cables
- 1 Oval plus 4 round entrance/exit for cables
- Integrated pressure valve
- Termination and splice kit included
- Integrated seal, air tight and waterproof
- Ideal for cable repair
- Suitable for aerial, underground duct or direct burial applications.
- Weight: 2,26 kg; Width: 223 mm; Depth: 450 mm



Article number	Description
2311002144	Enclosure FO DOME-01 IP68 48 Splices
2311002140	Enclosure FO DOME-02 IP68 72 Splices
2311002141	Enclosure FO DOME-03 IP68 96 Splices
2311002145	Enclosure FO DOME-04 IP68 144 Splices

Approved Trade Product, but no POLILAN product.

FO Box Ftth Indoor



2 fibers – SC or LCD connectors

Application

- Fiber optic box to terminate 1 or 2 fibers using LCD or SC adapters. Internal use.
- For Ftth applications.
- Multi cable entry points.
- Integrated fiber management.
- Include shutter to protect against lazer exposure and dust.

Standards

- TIA/EIA 568.C
- ISO/IEC 11801
- EN50173
- IEC60304
- IEC61754
- EN297-1



Product Specifications

- 2 fibers termination
- 8 cable entry points
- ABS Material
- White Color
- Support 2x SC simplex or LC duplex
- 86mm(Height) x 86mm(Width) x 25mm(Depth)

8 fibers – SC or LCD connectors

Application

- Internal fiber optic box to terminate up to 8 fibers using LCD or SC adapters flangeless.
- For ftth applications.
- Multi cable entry points.
- Integrated fiber management.

Standards

- TIA/EIA 568.C
- ISO/IEC 11801
- EN50173
- IEC60304
- IEC61754
- EN297-1



Product Specifications

- 2 fibers termination
- 8 cable entry points
- ABS Material
- White Color
- Support 2x SC simplex or LC duplex
- 86mm(Height) x 86mm(Width) x 25mm(Depth)

Article number	Description
2311001190	BOX FO CSB07 2XSC/LCD
2311004382	BOX FO CSB15 4XSC/LCD

Approved Trade Product, but no POLILAN product.

Adapter LC & SC

ROHS

**Application**

Fiber optic adapters LC or SC to be used fiber optic enclosures or patch panels.

- Data Center
- Telecommunication Networks
- Ethernet, Fiber Channel, ATM, LAN, MAN and WAN

Standards

- IEC 61754-20
- IEC 61300-3-4
- IEC 61300-2-2
- IEC 61754-20
- IEC 61300-2-22
- REACH SvHC compliant

**Product Specifications**

High precision alignment sleeves for reliability and improved reconnectability. For single mode and multimode applications a ceramic sleeve is supplied. The housing is available in different colors with options for flange or flangeless body, metalclips or inbuilt clips.

A protective cap is provided at each end of the adapter with the same color as the adapter.

Product Specification

	CERAMIC	CONFORMANCE
Insertion Loss (Typ)	0.1 dB	IEC 61300-3-4
Mating Durability	500	IEC 61300-2-2
Receptacle Retention Force	1 N - 5.9 N	IEC 61754-2
Operating Temperature	-25 to +70 °C, 12 cycles	IEC 61300-2-22

Article number	Description	Format	Color
2311001022	Adapter LC DPX MM	Duplex	Bege
2311001035	Adapter LC DPX MM TQ	Duplex	Turquoise
2311001034	Adapter LC DPX MM VT	Duplex	Violet
2311001023	Adapter LC DPX SM	Duplex	Blue
2311001028	Adapter LC QUAD MM TQ	Quad	Turquoise
2311001024	Adapter LC QUAD SM BU	Quad	Blue
2311001027	Adapter LC SPX SM	SPX	Blue
2311001010	Adapter LC/APC DPX SM	Duplex	Green
2311001017	Adapter SC - SC DPX MM	Duplex	Bege
2311003749	Adapter SC - SC DPX MM TQ	Duplex	Turquoise
2311003755	Adapter SC - SC DPX MM VT	Duplex	Violet
2311001019	Adapter SC - SC DPX SM	Duplex	Blue
2311001018	Adapter SC/A - SC/A DPX SM	Duplex	Green
2311001015	Adapter SC- SC SPX MM	Simplex	Bege
2311003747	Adapter SC - SC SPX MM TQ	Simplex	Turquoise
2311003745	Adapter SC - SC SPX MM VT	Simplex	Violet
2311001014	Adapter SC - SC SPX SM	Simplex	Blue
2311001016	Adapter SC/A - SC SPX SM	Simplex	Green

Approved Trade Product, but no POLILAN product.

Adapter ST



Description

The ST adapters have high precision alignment sleeves for reliability and better reconnectability.

ST adapters come with a ceramic sleeve for both singlemode and multimode adapters.

- Complies with IEC 61754-2
- Low insertion loss and high reconnectability capability
- REACH SvHC compliant
- Materials compliant to RoHS2
- Available in simplex or duplex

Product Dimension

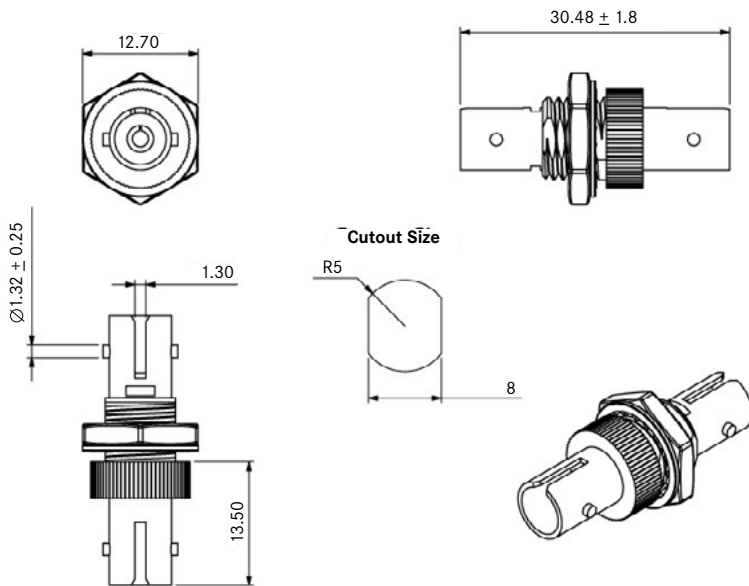

Product Specification

	CERAMIC	CONFORMANCE
Insertion Loss (Typ)	0.1 dB	IEC 61300-3-4
Mating Durability	500	IEC 61300-2-2
Receptacle Retention Force	2 N - 5.9 N	IEC 61754-2
Operating Temperature	-25 to +70 °C, 12 cycles	IEC 61300-2-22

Article number	Description
2311001020	Adapter ST - ST SPX SM
2311001021	Adapter ST - ST SPX MM
2311001025	Adapter ST - ST SPX MM SC FOOTPR
2311001026	Adapter FC - ST SPX SM
2311001030	Adapter SC - ST SPX SM

Approved Trade Product, but no POLILAN product.

Pigtail Fiber Optic



ROHS

LSZH



Application

Standard pigtails provide an optimized and cost effective solution for most applications including enterprise, lan, and datacom. To be used on Patch panels, wall boxes, ODFs and splice cassettes.

Standards

- IEC 61300-3-4
- IEC 61300-3-6
- IEC 61300-3-34
- REACH & SvHC compliant



Product Features

- Available in different fiber types (SM – G.652D, G657, MM – OM1, OM2, OM3, OM4)
- Available with different connector types (LC, FC, SC, ST)
- Standard buffer low smoke zero halogen (LSZH) material with 900 micron diameter
- Zirconia ceramic ferrule connectors (Grade C)

Product Specification

	Single Mode	Multimode	Compliance
Max. Insertion Loss (IL)	0.30 dB	0.30 dB	IEC 61300-3-4
Average IL	0.30 dB	0.25 dB	IEC 61300-3-4
Return Loss (Min)	50 dB	20 dB	IEC 61300-3-6
Operating Temperature (°C)	-20 up to 60		
Length	1m		

Article number	Connector	Fiber type
2311002107	FC	SM
2311002098	LC	SM
2311002088	SC	SM
2311002103	ST	SM
2311002100	LC	OM4
2311002111	SC	OM4
2311002112	ST	OM4

Article number	Connector	Fiber type
2311002099	LC	OM3
2311002090	SC	OM3
2311002106	ST	OM3
2311002095	LC	OM2
2311002091	SC	OM2
2311002105	ST	OM2
2311002097	LC	OM1
2311002092	SC	OM1
2311002104	ST	OM1

Approved Trade Product, but no POLILAN product.

Patch Cord Fiber Single Mode Enhanced



Application

Single mode patch cords are used for telecom networks and also used for high speed metropolitan and access network. The single mode patch cords are manufactured using LSZH cables which conform to IEC, EIA TIA or Telcordia standards.

The OS2 enhanced patch cords are terminated with optimized connectors which give optimum optical performance.

Standards

- ITU-T G.652D
- ITU-T G.657A1 or A2
- TIA/EIA 492AAAB
- IEC60793-2-10 A1a.1a
- IEC 61300-3-4
- IEC 60332-1
- OS1/OS2

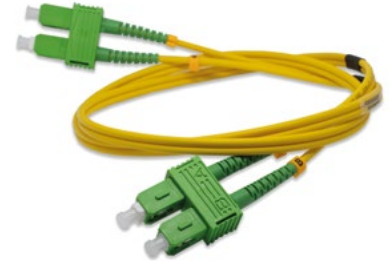

Product Features

- FC, LC, MTRJ, MU, SC and ST connectors, UPC and APC connectors.
- Low smoke zero halogen (LSZH) jacket in yellow color.
- 900 µm or 600 µm tight buffer.
- Simplex and duplex assemblies.
- Duplex assemblies available with clips (SC and LC).
- Different connector performance range for specific application available.
- Armoured option also available.
- REACH, RoHS & SvHC materials compliant.

Product Specifications	
IL Max/Master (Acceptance)	0.25 dB (IEC 61300-3-4)
Ave/Master	0.18 dB (IEC 61300-3-4)
Return Loss	55/65 dB (IEC 61300-3-6)
Cable Material	LSZH
Strength Member	Aramid
Crush (N)	1000
Operating Temperature (°C)	-20 to 60
Fire Specification	IEC 60332-1
Attenuation (dB/km)	0.38 @ 1310 nm / 0.25 @ 1550 nm
Chromatic Dispersion (ps/nm x km)	3.0 @ 1310 nm / 18.0 @ 1550 nm

Approved Trade Product, but no POLILAN product.

Patch cord Fiber Optic Enhanced OM3/Multimode



Application

Multimode patch cords are used to connect high speed and legacy networks like 10 gigabit ethernet, fast ethernet and ethernet. The multimode patch cords are manufactured for internal use using LSZH cables which conform to IEC, EIA TIA or Telcordia standards. The OM3 enhanced patch cords are terminated with optimized connectors which gives optimum optical performance.



Product Features

- E2000, FC, LC, MTRJ, SC and ST connectors.
- Low smoke zero halogen (LSZH) cable in aqua or purple color.
- 900 µm / 600 µm tight buffer.
- OM3 fiber conforms to ITU-T G.651.1, TIA/EIA 492AAAC, IEC60793-2-10 A 1a.2a.
- Reduced Bend Sensitivity (RBS) fiber used as standard.
- Simplex and duplex assemblies.
- Duplex assemblies available with clips (SC and LC).
- Different connector performance range for specific application available.
- Armoured option also available.

Product Specifications

IL Max/Master (Acceptance)	0.25 dB (IEC 61300-3-4)
Ave/Master	0.15 dB (IEC 61300-3-4)
Ave/Random	0.20 dB (IEC 61300-3-34)
Return Loss	28 dB (IEC 61300-3-6)
Cable Material	LSZH
Strength Member	Aramid
Crush (N)	1000
Operating Temperature (°C)	-20 to 60
Fire Specification	IEC 60332-1
Attenuation (dB/km)	2,8 @ 850nm / 0,8 @ 1310 nm
Bandwidth OFL (Mhz x km)	1500 @ 850 nm / 500 @ 1310 nm

Approved Trade Product, but no POLILAN product.

Patch Cord Fiber Multimode Enhanced OM4



Application

Multimode OM4 patch cords are used to connect high speed and legacy networks like 10/20/100 gigabit, fast ethernet and ethernet.

The multimode patch cords are manufactured for internal use using LSZH, OFNR or OFNP cables which conform to IEC, EIA TIA or Telcordia standards.

The OM4 enhanced patch cords are terminated with optimized connectors which give optimum optical performance.

Standards

- ITU-T G.651.1
- TIA/EIA 492AAAD
- IEC60793-2-10 A 1a.3a
- IEC 61300-3-4
- IEC 60332-1



Product Features

- FC, LC, MTRJ, MU, SC and ST connectors.
- Low smoke zero halogen (LSZH) jacket in Erika violet color or aqua as option.
- 900 µm or 600 µm tight buffer.
- Simplex and duplex assemblies.
- Duplex assemblies available with clips (SC and LC).
- Reduced Bend Sensitivity (RBS) OM4 fiber used as standard.
- Higher optical performance available on request.
- REACH, RoHS & SvHC materials compliant.

Product Specifications	
IL Max/Master (Acceptance)	0.25 dB (IEC 61300-3-4)
Ave/Master	0.15 dB (IEC 61300-3-4)
Cable Material	LSZH/OFNR/OFNP
Strength Member	Aramid
Crush (N)	1000
Operating Temperature (°C)	-20 to 60
Fire Specification	IEC 60332-1
Attenuation (dB/km)	2,8 @ 850 nm / 0,8 @ 1310 nm
Bandwidth OFL (Mhz x km)	3500 @ 850 nm / 500 @ 1310 nm

Approved Trade Product, but no POLILAN product.

Fibre Optic Consumables

Cleaning Pen's



Application

Easy-to-use solution for cleaning fiber optic connectors on jumpers and in adapters. Since over 85% of network outages are attributed to dirty and/or damaged connectors, it is critical to clean every connector.

- Removing oil, dust, and dirt without damaging delicate fiber end-faces.
- Both dry and wet cleaning (add cleaning fluid).
- Clean connectors in tight spaces.
- Field or laboratory use.

Product Features

- Patented single-action cleaning in a small ergonomic design
- Variety of sizes and types for different connector styles
- Cleans connectors in both jumpers and bulkhead adapters
- Low cost per clean
- >500 cleanings (typical value)

Article number	Description
2311001007	TOOL FO CLEANING PEN LC/MU 1,25MM
2311004209	TOOL FO CLEANING PEN DPX LC
2311090065	TOOL FO CLEANING PEN SC/ST/FC 2,5MM
2311001008	TOOL FO MPO CONNECTOR CLEANING

Approved Trade Product, but no POLILAN product.



One-Click
Cleaner
MU/LC



One-Click
Cleaner
D-LC



One-Click
Cleaner
SC



One-Click
Cleaner
MPO



RACKS

NETWORK RACK FP - PEDESTAL	80
RACK NETWORK AND SERVER NS - PEDESTAL	82
WALL RACK FP	84
ACCESSORIES FOR 19" RACKS	86
MANAGEMENT CABLE BAR 1U BK	87
SHELF FOR 19" RACKS	88

Network Rack FP Pedestal



Application

- Exquisite design with precise craftsmanship.
- Good compatibility, adapt to more servers.
- Rack's side panel can be easily assembled.
- Efficient and solid cabinet connection.
- The top and bottom wiring channel can be closed and adjusted.
- Adjustable feet and castors are included.
- Loading: 800kg (with adjustable feet).
- Advanced lock.
- Surface finish: decreasing, pickling, phosphating, powder coating.
- Available in black.
- Supplied in flat pack for easy and economy transport (divided in 3 volumes).

Standards

- ANSI/EIARS-310-D
- DIN41491
- PART1, IEC297-2, DIN41494
- PART7, GB/T3047.2-92
- Compatible with metric ETSI and 19inch international standard



Materials

- Cold-rolled steel sheet.
- Frame: 1,2 mm thickness.
- Mounting rail: 2,0 mm.
- Side panel: 1,2 mm.
- Thickness for smoky grey glass 5 mm.



Lockable side panels

Are removable with handle for better handling



Doors

Are removable with locking latches and do not require tools



Feet

Solid levelers and multi-directional casters



Fans

Supplied as accessory can support up to 4 fans



Door Lock Front and Rear



Rectangle Ventilation Hole



Mounting Rail With U Marks



Bottom Plate Supplied as With lower adjustable blind plates

Network Rack FP Pedestal

ACCESSORIES



Digital Temperature Unit
Thermostat and give direct temperature information

(PN 2311003659)



Cooling Fan
With 2 fan, can be upgrade up to 4 fansrack

(PN 2311003660)



PDU
With 6 or 8 sockets, with Security switch or main switch

(PN 2311000957)
(PN 2311000956)

Article number	Description	Front door	Rear door	Dimension (HxWxD)
2311003653	Rack NETW 42U 80x80 Flat pack	Smoky-gray glass	Blind steel	2080x830x830 mm
2311004605	Rack NETW 42U 80x80 Flat pack	Perfurated door	Blind steel	2080x830x830 mm

Rack Network and Server NS Pedestal



Application

- 19" network and server racks to store and protect servers communication equipments.
- Patching.
- Good compatibility, adapt to more servers.
- Efficient and solid cabinet connection.
- The top and bottom wiring channel can be closed and adjusted.
- Supplied with adjustable feet.
- Keylock in included in doors and side panels.
- Available in black: RAL 9005 textured and electrostatic painting.
- Supplied mounted.

Standards

- Compatible with metric ETSI and 19inch international standard



Materials

- Roof and base: 1,8mm galvanized steel sheet.
- Doors: 1,25mm galvanized steel sheet.
- Side panels: 0,8mm galvanized steel sheet

Door Options

Several Door Types
Perfurated, smoked glass or blind



Single



Double

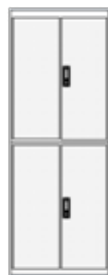

Double H



Triple H

Rack Network and Server NS Pedestal

External Dimensions (cm)						
Width	Depth	20U	24U	33U	42U	47U
60	80	112	128	164	200	220
60	80	112	128	164	200	220
60	100	112	128	164	200	220
80	60	112	128	164	200	220
80	80	112	128	164	200	220
80	100	112	128	164	200	220

ACCESSORIES



Digital Temperature Unit
Thermostat and give direct temperature information

(PN 2311003659)



Cooling Fan
With 2 fan

(PN 2311000976)



PDU
With 6 or 8 sockets, with Security switch or main switch

(PN 2311000957)
(PN 2311000956)

Article number	Description	Front Door	Rear Door	Dimension (HxWxD)
2311001075	Rack 24U 60x60	Single, glass	Blind steel	1280x600x600
2311001076	Rack 24U 60x80	Single, glass	Blind steel	1280x600x600
2311002881	Rack 24U 80x100 M2,M2, PLC,PLC	Double, perforated	Double, perforated	1280x800x1000
2311001077	Rack 33U 60x60 PV,PC,PLC,PLC	Single, glass	Blind steel	1640x600x600
2311001078	Rack 33U 60x80	Single, glass	Blind steel	1640x600x800
2311001083	Rack 33U 80x100	Single, glass	Perforated	1640x800x1000
2311001079	Rack 33U 80x80	Single, glass	Blind steel	1640x800x800
2311001081	Rack 42U 60x60 perf.door + blind door	Single, perforated	Blind steel	2000x600x600
2311002950	Rack 42U 60x80 PV,PC,PLC	Single, glass	Single, glass	2000x600x800
2311001082	Rack 42U 80x100 M2,M,PLC,PLC	Double, perforated	Single, perforated	2000x800x1000
2311001087	Rack 42U 80x80 M2,M2,PLC,PLC	Double, perforated	Double, perforated	2000x800x800
2311001080	Rack 42U 80x80	Single, glass	Blind steel	2000x800x800
2311004603	Rack 42U 80x100 PV,PM, BK	Single, glass	Single, perforated	2000x800x1000

Approved Trade Product, but no POLILAN product.

Wall Rack FP**Application**

- Exquisite design with precise craftsmanship
- Can easily be mounted on wall or placed on floor after installed feet or castor.
- Rack's side panel can be easily assembled.
- Efficient and solid cabinet connection.
- The top and bottom wiring channel can be open or closed.
- Removable front door and side panel, easily installing and maintaining.
- Loading: 60kg.
- Advanced lock.
- Surface finish: decreasing, pickling, phosphating, powder coating.
- Available in black.
- Supplied in flat pack for easy and economy transport (1 volume).

Standards

- ANSI/EIARS-310-D
- DIN41491
- PART1, IEC297-2, DIN41494
- PART7, GB/T3047.2-92
- Compatible with metric ETSI and 19 inch international standard.

**Materials**

- Cold-rolled steel sheet.
- Frame, doors and panels: 1,2 mm thickness.
- Mounting rail: 1,5mm.
- Thickness for smoky grey glass 5mm.



Lockable side panels
Are removable very easily with handle but can also be lockable



Vertical cable ladders
Are used to attach cable and PDU (power distribution units)



Front doors
Smoky-grey glass door, but other option exist (steel or perforated)



Fans
Supplied as accessory, can support up to 2 fans

Wall Rack FP

Dimensions (mm)					
Capacity (RU)	Width (mm)	Depth (mm)	Height (mm)	Carton measurement WxDxH (mm)	Volume (CBM)
6U	600	450	368	670x620x430	0,18
9U	600	550	501	670x620x560	0,23
12U	600	550	635	670x620x700	0,29
15U	600	550	789	670x620x830	0,34

ACCESSORIES

**Digital Temperature Unit**

Thermostat and give direct temperature information

(PN 2311003659)

**Thermostat**

For easily control the fans operation

(PN 2311000953)

**Cooling Fan**

For cooling the rack

(PN 2311003661)

**PDU**

With 6 or 8 sockets, with Security switch or main switch

(PN 2311000957)
(PN 2311000956)

Article number	Description	Capacity (RU)	Depth (mm)	Color
2311003655	Rack Wall 6U 60x45 V,2 PLC UN BK POLI	6U	45	Black
2311003657	Rack Wall 9U 60x60 V,2 PLC UN BK POLI	9U	60	Black
TBD	Rack Wall 12U 60x60 V,2 PLC UN BK POLI	12U	60	Black
TBD	Rack Wall 15U 60x60 V,2 PLC UN BK POLI	15U	60	Black

Rack Accessories

For 19" Racks



THERMOSTAT

Application

To control the rack's ventilation kit.
Support not included.

Standards

- EN 55014-1-2
- EN 61000-3-2
- EN 61000-3-3



Product Specifications

- Input and output voltage: 220V
- Connection 2-pole terminal for 2,5mm²
- Clip for 35mm DIN rail
- Plastic UL94 V-0 Light Grey Color
- Contact resistance <10m
- 60mm(Height) x 33mm(Width) x 43mm(Depth)

THERMOSTAT WITH DISPLAY

Application

To control the rack's ventilation kit with digital display given immediate information about rack's temperature.



Product Specifications

- Measuring range: 1 ~ 99°C
- Affiliated sensor: NTC thermistor sensor
- Sampling rate: 500ms
- Output type: master relay output, internal buzzer alert
- To be used on 19" rack's

RACK VENTILATORS



(PN 2311003661)



(PN 2311003660)

Article number	Description
2311000953	Rack thermostat
2311003659	Thermostat with display
2311000968	Rack Vent 1FAN
2311000976	Rack Vent 2FAN
2311003661	Rack Vent 1FAN for FP rack
2311003660	Rack Vent 2FAN for FP rack

Approved Trade Product, but no POLILAN product.

Management Cable Bar 1U BK

Application

Management cable bars is suitable for 19" racks, 1U.

For cable routing and management inside racks.

Data centers, premise installations, telecommunication networks.

Standards

- ISO/IEC 11801
- TIA/EIA 568.C
- EN50173
- IEC60304
- IEC61754



(PN 2311001887)



(PN 2311002862)

Design

- Versions with brush, with rings and with brush and rings.

Article number	Description	External dimensions (mm)	Color	N° rings
2311001887	Manage Cable Bar 19" 1U w/Brush	44(H)x482.6(W)x44(D)	Black	NA
2311001882	Manage Cable Bar 19" 1U BK w/Rings	44(H)x482.6(W)x88(D)	Black	4 (74mm deep)
2311002862	Manage Cable Bar 19" 1U BK w/5 Rings	44(H)x482.6(W)x77(D)	Black	5 (68mm deep)
2311003107	Manage Cable Bar 19" 1U W/Brush w/Rings	44(H)x482.6(W)x88(D)	Black	4 (74mm deep)

Shelf**For 19" Racks****Application**

To be installed on a 19" racks, it is used to support communications devices, manuals or other equipments that needs to be stored inside the rack.

It has versions with frontal mounting (2 points) or with four fixing points.

Standards

- ANSI/EIARS-310-D
- DIN41491
- PART1, IEC297-2, DIN41494
- PART7, GB/T3047.2-92
- Compatible with metric ETSI and 19inch international standard.

Materials

- Cold-rolled steel sheet
- 1,5mm thickness



Shelf 19" 2 Fixpoints BK 400mm
(2311090435)

Shelf 19" 4 Fixpoints BK Adjustable
(2311000988)

Article number	Description	Fixing points	Height (RU)	Depth (mm)
2311000985	Shelf 19" 2 Fixpoints BK 250mm	2	1U	250
2311000945	Shelf 19" 2 Fixpoints 350mm	2	1U	350
2311090435	Shelf 19" 2 Fixpoints 400mm	2	1U	400
2311000980	Shelf 19" 2 Fixpoints BK 450mm	2	1U	450
2311003063	Shelf 19" 2 Fixpoints BK 600mm	2	1U	600
2311000988	Shelf 19" 4 Fixpoints Adjust 425-760mm	4	1U	Adjustable
2311000981	Shelf 19" 4 Fixpoints BK 600mm	4	1U	600
2311003089	Shelf 19" 4 Fixpoints BK 1000mm	4	1U	1000

Approved Trade Product, but no POLILAN product.



TECHNICAL GUIDE

IP PROTECTION GRADE IEC/EN 60529	92
FIBER OPTIC CABLES - DESIGNATION CODE	93
STANDARDS FOR COPPER DATA CABLES AND FIBER OPTIC	94
AWG WIRE SIZES AND POE TYPES	95
CONSTRUCTION PRODUCTS REGULATION (CPR)	96

IP Protection Grade IEC/EN 60529

Waterproof and Dustproof Grade

Application

The IEC has developed the ingress protection (IP) ratings, which grade the resistance of an enclosure against the intrusion of dust or liquids.

The ratings are widely used throughout industry.

The IP code is composed of two numerals:

- The first refers to the protection against solid object (scale 0 up to 6).
- The second refers the rate protection against liquids (scale 0 up to 9).

Standards

- IEC/EN 60529

Example:

IP65

Protection against water jets

Complete protection against solid objects

1 st Digit (Solid objects)	Explanation	2 nd Digit (Water ingress)	Explanation
0	No protection	0	No protection
1	Protection against solid bodies larger than 50mm	1	Protection against vertically falling drops of water (condensation)
2	Protected agains solid bodies larger than 12,5mm	2	Protection against drops of water falling up to 15° degrees from vertical
3	Protected agains solid bodies larger than 2,5mm	3	Protection against spraing water
4	Protected agains solid bodies larger than 1mm	4	Protected against projections of water from all directions
5	Protected agains dust	5	Protection against water jets
6	Completed protected	6	Protection against powerfull water jets
		7	Protection against the effects of temporary immersion in water
		8	Protection against the effects of continuous immersion in water
		9	Protection against high pressure and temperature water jets

Fiber Optic Cables - Designation Code

DIN VDE 0888

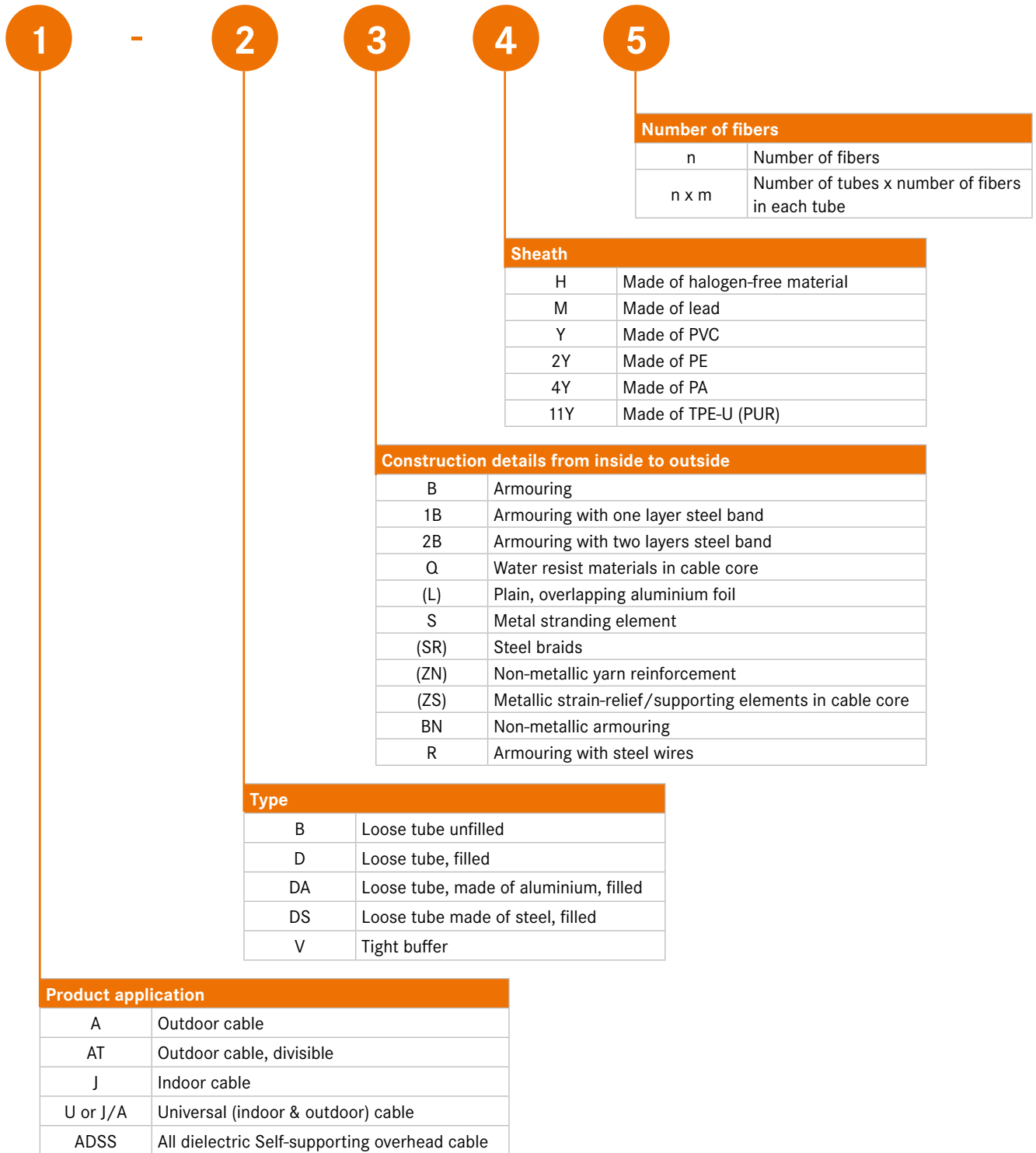

Example:

J-V(ZN)H 8x1 E9/125

Indoor cable with 8 tightly buffered fibers (singlemode) and halogenfree outer sheath, yarn reinforcing under the sheath.

A-DQ(ZN)SR(2Y) 4x12 G50/125 OM2

Outdoor cable with filled loose tube and swellable dry water blocking in the core with polyethylene sheathing. Yarn reinforcement under the corrugated steel tape armour. The cable has 4 tubes with 12 fibers 50/125 OM2 each.

Standards for Copper Data Cables and Fiber Optic

SYMMETRICAL COPPER DATA CABLES

Standard	Subject
ISO/IEC 11801	Information technology and application-independent wiring systems.
IEC 61156	Multiconductor and symmetrical pair-/star quad twisted cable for the digital communication transmission.
EN 50173	Information technology: Generic cabling Part 1: General requirements Part 2: Office premises Part 3: Industrial premises Part 4: Homes Part 5: Data centres Part 6: Distributed building services
EN 50174	Information technology: Cabling installation Part 1: Specification and quality assurance Part 2: Installation planning and practices inside buildings Part 3: Installation planning and practices outside buildings
EN 50288	Multiconductor metallic data and control cables for an analogue and digital transmission.
EN 55022	EMC standards for office surroundings.
EN 50575	Power, control and communication cables. Cables for general applications in construction works subject to reaction to fire requirements.
EN 50399	Common test methods for cables under fire conditions - Heat release and smoke production measurement on cables during flame spread test - Test apparatus, procedures, results.
EN 13501	Fire classification of construction products and building elements.

FIBER OPTIC CABLES

Standard	Subject
IEC 60793-1	Fiber optic characteristics
IEC 60794-1	Fiber optic cable characteristics
IEC 60331-25 / EN50200 PH30/PH120	Fire resistant test procedure Circuit integrity
IEC 60332-3 / EN60332-3	Fire retardant test procedure
IEC 60332-1 / EN60332-1	Flame retardant test procedure
IEC 61034-2 / EN61034-2	Low smoke emission test procedure

Test method	Test type	Test criteria
IEC 60794-1-2-E1	Tensile performance	Fibre elongation
IEC 60794-1-2-E3	Crush resistance	Fibre attenuation
IEC 60794-1-2-E4	Impact	No damage to the sheath and cable elements
IEC 60794-1-2-E6	Repeated bending	No fibre break
IEC 60794-1-2-E11	Bend	Fibre attenuation
IEC 60794-1-2-E7	Torsion	Fibre attenuation
IEC 60794-1-2-F5	Water penetration	Water penetration
IEC 60794-1-2-F1	Temperature cycling	Fibre attenuation

AWG Wire Sizes and POE Types

AWG WIRE SIZES

AWG	Min. Diameter Solid Conductor ^(a) (mm)	Cross Section Stranded Conductor ^(a) (mm ²)
18	1.013	0.807
19	0.866 ^(b)	0.641
20	0.772 ^(b)	0.509
21	0.688 ^(b)	0.404
22	0.610 ^(b)	0.318
23	0.546 ^(b)	0.254
24	0.485 ^(b)	0.201
25	0.432 ^(b)	0.159
26	0.384 ^(b)	0.126
27	0.358	0.100
28	0.318	0.079

^(a) According to UL 444 as of 11 July 2008

^(b) Minimum acceptable diameter (0.95 x nominal) of a solid conductor of this size

POE TYPES

POE (Power Over Ethernet) is the capability to transport on the same cable energy and communication.

Standard	Name	Type	Class	Power Source Equip (PSE)	Powered Device (PD)	Pairs
802.3af	POE	Type 1	Class 1	4W	3.84W	2
			Class 2	7W	6.5W	2
			Class 3	15.4W	12.95W	2
802.3at	POE+	Type 2	Class 4	30W	25.5W	2
802.3bt	POE++ 4PPOE	Type 3	Class 5	45W	40W	4
			Class 6	60W	51W	4
		Type 4	Class 7	75W	62W	4
			Class 8	90W	72W	4

Due to the high power need to transport, especially on 802.3bt it is recommended to use cables with AWG23 or AWG22.

Construction Products Regulation (CPR)

The use of cables in construction works is practically as old as the transmission of electrical power itself. However, the classification of cables as a construction product only gained momentum when (CPR) Regulation (EU) no. 305/2011 came into effect in July 2013, and when the European standard EN 50575 was published in September 2014.

Date of applicability of the regulation was at 10 of June of 2016.

This refers to cables within the scope of application of a harmonised standard, namely EN 50575:2014 + A1:2016.

The Fire Behaviour is the CPR new classification for cables, this regulation establish rules for the security of products.

The cables must comply with the 7 class of CPR, the next table shows them and the tests that apply to each class:

CPR Class	Classification criteria	Additional criteria	AVCP System
A _{ca}	EN ISO 1716 Gross heat of combustion		"1+", including: • Initial type-testing and continuous surveillance • Audit & testing of samples by 3 rd party certification body
B1 _{ca}	EN 50399 Heat release	Smoke production (s1a, s1b, s2, s3) EN 50399/EN 61034-2	
B2 _{ca}	Flame spread EN 60332-3		
C _{ca}	Fire retardant EN 60332-1-2 Flame retardant	Acidity (a1, a2, a3) EN 60754-2	"3", including: • initial type-testing by 3 rd party laboratory • factory production control by manufacturer
D _{ca}	EN50399 Heat release Flame spread EN60332-1-2 Flame retardant	Flaming droplets (d0,d1,d2) EN 50399	
E _{ca}	EN 60332-1-2 Flame propagation		"4": • Initial type-testing and factory production control by manufacturer
F _{ca}	EN 60332-1-2 Flame propagation (not conform with E _{ca} Class)		

Example of a DoP:

DECLARAÇÃO DE DESEMPENHO
de acordo com o Anexo III do regulamento (EU) Nº 305/2011
Declaration of Performance
according to Annex III of Regulation (EU) no. 305/2011

Documento nº: **POLILAN20_V01**
Documento: **CC U/UTP CAT4 4P LSZH WH**

1. Código de identificação único de produto: **CC U/UTP CAT4 4P LSZH WH**
1. Unique identification code of the product

2. Utilização prevista:
2. Intended use:
Fornecimento de energia e/ou comunicações em edifícios e obras de construção civil sujeitas a requisitos de reação ao fogo.
Electricity supply and/or communications in buildings and other structures with the aim of limiting the generation and spread of fire and smoke.

3. Fabricante: **Policabos - Soluções Técnicas de Cadeirinhas S.A.**
3. Manufacturer
4. Endereço: **Policabos - Soluções Técnicas de Cadeirinhas S.A., Estrada das Torres de Lagoa, 43-47, 2635-595 Rio de Mouro, Portugal**

4. Sistema de avaliação e verificação de conformidade do desempenho:
4. System of assessment and verification of constancy of performance:
Sistema 3 / System 3

5. Esta declaração de desempenho refere-se a um produto de construção coberto pela norma harmonizada **EN 50575:2014+A1:2016**.
5. This Declaration of Performance concerns a construction product covered by the harmonized standard **EN 50575:2014+A1:2016**.

6. Organismo notificado: **0652 DP Third Party Testing, Agens Alle 5, 2970 Hørsholm Denmark**
6. Product certification body

7. Desempenho declarado:
7. Declared performance

Características essenciais	Desempenho	Especificações técnicas harmonizadas
Reação ao fogo	Classificação: Dca	EN 50575:2014 + A1:2016
Flamação por gotas	Classe: +2,2,2,1	
Produção de fumo	Classe: S1a	
Acidez	Classe: A1	

8. O desempenho do produto referido nos parágrafos 1 a 6 está conforme o desempenho declarado na secção 7.
8. The performance of the relevant product in paragraph 1 to 6 is conform with the declared performance in Section 7.

Esta declaração de desempenho é emitida sob a responsabilidade geral do fabricante na secção 3. Fabricante
This declaration of performance is issued under the general responsibility of the manufacturer in section 3. Manufacturer

Assinado por e em nome do fabricante por:
Signed for and on behalf of the manufacturer by:
POLICABOS - Soluções Técnicas de Cadeirinhas S.A.
Cadafeira, Estrada das Torres de Lagoa, 43-47, 2635-595 Rio de Mouro, Portugal
Tel: +351 21 291 178 640
Fax: +351 21 291 178 640
E-mail: info@policabos.pt

13/10/2016

On our website you will find detailed information about application of the CPR regarding cables: <http://policabos.pt>

Photographs and graphics are not to scale and do not represent detailed images of the respective products.

All printing errors are subject to correction in subsequent releases of this document. The specifications of all products contained are subject to change without notice.

JUNE 2023. LAPP POLICABOS.

POLILAN®

Network Infrastructures

Follow Lapp on



Terms of trade:

Our general conditions of sale
can be downloaded from our website
www.policabos.pt

 **LAPP** Policabos

LAPP Portugal

Pinhal dos Três Cantos, Estrada Terras de Lagoa, 43-47
2635-595 RIO DE MOURO • PORTUGAL

Phone: +351 219 178 640 • Fax: +351 219 178 649
www.policabos.pt • comercial@policabos.pt